

Ferrite

EE, ER and EEM Series

For Switching Power Supplies
SMD Cores

Cores

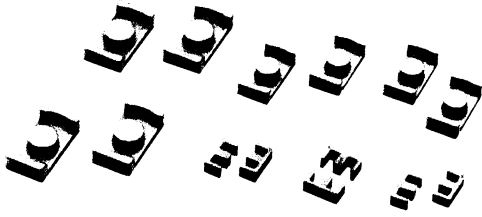

Part No.	Type	Dimensions in		C ₁	C ₂	E	F	2H
		mm	inches					
PC44EE5-Z	1	5.25±0.05 .207±.002	5.3±0.1 .209±.004	1.35±0.05 .053±.002		0.70±0.05 .028±.002	1.95±0.05 .077±.002	4.0 .157
PC44EE8.9/8-Z	1	8.86±0.20 .349±.008	8.0±0.3 .315±.012	1.90±0.12 .075±.005		1.91±0.20 .075±.008	1.90±0.12 .075±.008	4.5±0.3 .177±.012
PC44ER9.5/5-Z PC50ER9.5/5-Z	2	9.35±0.15 .368±.006	4.9±0.1 .193±.004	3.4±0.1 .134±.004			4.9±0.1 .193±.004	3.35±0.15 .132±.004
PC44ER11/3.9-Z PC50ER11/3.9-Z	2	10.83±0.18 .426±.007	3.85±0.10 .152±.004	4.13±0.13 .163±.005			5.9±0.1 .232±.004	2.10±0.15 .083±.006
PC44ER11/5-Z PC50ER11/5-Z	2	10.83±0.18 .426±.007	4.9±0.1 .193±.004	4.13±0.13 .163±.005			5.9±0.1 .232±.004	3.15±0.15 .124±.006
PC44ER14.5/6-Z PC50ER14.5/6-Z	2	14.5±0.2 .571±.008	5.9±0.1 .232±.004	4.7±0.1 .185±.004			6.7±0.1 .264±.004	3.3±0.2 .130±.008
PC44EEM12.7/13.7-Z PC50EEM12.7/13.7-Z	3	12.75±0.25 .502±.010	13.7±0.3 .539±.012	6.0±0.1 .236±.004	1.85±0.10 .073±.004	1.7±0.1 .067±.004	3.30±0.15 .130±.006	9.1±0.3 .358±.012

Bobbins

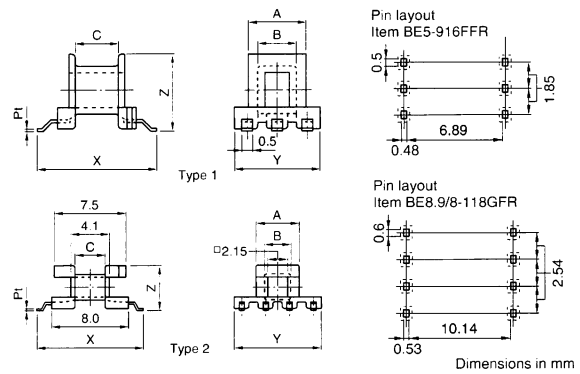
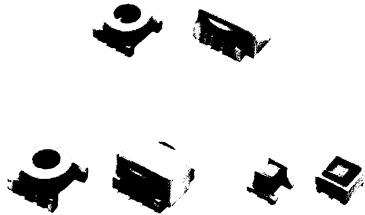

Part No.	Type	Dimensions in		C	X	Y	Z
		mm	inches				
BE5-916FFR BE5-926F1FR	1	3.5 .138	2.3 .091	2.7 .106	7.85 .309	5.2 .205	4.65 .183
BE8.9/8-118GFR	2	4.5 .177	2.7 .106	3.1 .122	11.2 .441	9.2 .362	4.75 .187
BEM12.7-118GAFR	3	8.9 .350	6.9 .272	7.5 .295	16.7 .657	12.8 .504	4.9 .193
BER9.5/5-118GAFR	4	7.3 .287	4.45 .175	2.15 .085	11.5 .452	8.6 .339	4.45 .175
BER11/3.9-1110GAFR	4	8.5 .335	5.2 .205	1.05 .041	12.45 .490	10.5 .413	3.4 .134
BER11/5-1110GAFR**	4	8.5 .335	5.2 .205	1.95 .077	12.2 .480	10.5 .413	4.70 .185
BER14.5/6-1110GAFR	4	11.4 .449	5.9 .232	2.0 .079	16.0 .630	14.0 .551	5.75 .226

** 8-pin is available (Part No. BER11/5-118GAFR).

Ferrite

EE, ER and EEM Series

For Switching Power Supplies
SMD Cores

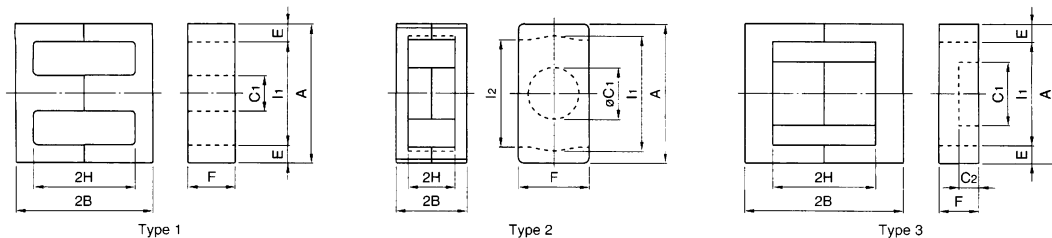

H	l ₂	Effective parameter				Electrical characteristics		Wt (g)	Bobbin item
		C ₁ (mm ⁻¹)	A _e (mm ²)	ℓ _e (mm)	V _e (mm ³)	AL-value (nH/N ²) Without air gap	With air gap		
3.85 .152		4.72	2.67	12.6	33.6	200 min.		0.2	BE5-916FFR
5.08 min. .200 min.		3.15	4.96	15.6	77.4	480±25%		0.6	BE8.9/8-118GFR
7.63±0.13 .300±.005	7.0 min. 276 min.	1.68	8.47	14.2	120	610 min. 750±25%	63±5% 100±7%	0.6	BER9.5/5-118GAFR
8.85±0.15 .348±.006	7.9 min. .311 min.	1.08	11.7	12.6	147	1040 min. 1100±25%	63±5% 100±7%	0.8	BER11/3.9-1110GAFR
8.85±0.15 .348±.006	7.9 min. .311 min.	1.24	11.9	14.7	175	870 min. 960±25%	63±5% 100±7%	1.0	BER11/5-1110GAFR
11.8±0.2 .465±.008	11.8±0.2 .465±.008	1.08	17.6	19.0	334	1280 min. 1150±25%	100±5% 160±7%	1.8	BER14.5/6-1110GAFR
9.0 min. .354 min.		2.28	12.0	27.3	328	820±25% 580±25%	40±5% 63±7%	1.9	BEM12.7-118GAFR

* AL-value: 1kHz, 0.5mA, 100Ts

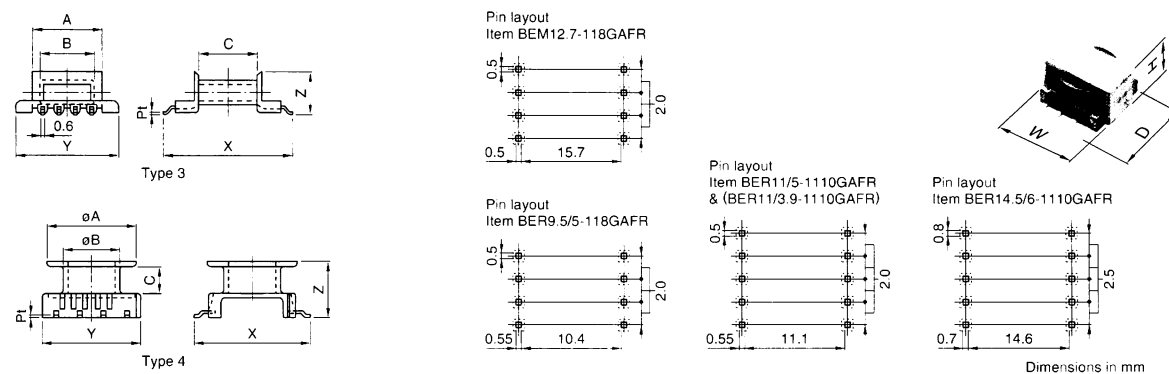

t*	Pt×Pw (mm)	Terminal pins	Parameter			Material	Wt (g)	Accessory item
			w D (mm) H	Aw (mm ²)	ℓ w (mm)			
0.4	0.2×0.5	6	5.7 7.8 4.8	1.62	12.4	Diallyl Phtalate	0.03 0.07	FE-5-A
0.2	0.2×0.6	6	9.3 11.3 4.8	2.79	14.4	FR Phenol	0.17	—
0.35	0.3×0.5	8	13.6 16.8 5.0	7.5	22.4	FR Phenol	0.31	FEM12.7/13.7-A
0.4	0.3×0.5	8	9.9 11.7 5.9	3.06	18.5	FR Phenol	0.16	FER9.5/5-A
0.4	0.25×0.7	10	11.0 12.6 4.7	1.73	21.5	FR Phenol	0.21	FER11/3.9-A
0.4	0.3×0.5	10	11.5 12.3 6.4	3.22	21.5	FR Phenol	0.21	FER11/5-A
0.4	0.3×0.8	10	15.1 16.2 7.3	5.5	27.2	FR Phenol	0.55	FER14.5/6-A

UL Grade: 94V-0. Material of pins: F, G types are Phosphor bronze wire (Solder plated). GA type is Steel wire (Solder plated).
Maximum number of turns N that can be wound on bobbins. see section of "Maximum number of Turns on Bobbins".

* Minimum thickness of bobbin.

• All specifications are subject to change without notice.

ER 9,5/5
Core
B65523

- In accordance with IEC 61860
- For transformers featuring high inductance and low overall height
- ER9,5 cores are supplied in sets

Magnetic characteristics (per set)

$$\Sigma l/A = 1,54 \text{ mm}^{-1}$$

$$l_e = 13,6 \text{ mm}$$

$$A_e = 8,81 \text{ mm}^2$$

$$V_e = 120 \text{ mm}^3$$

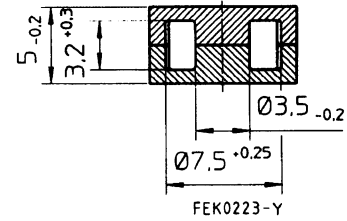
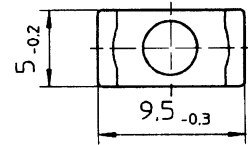
Approx. weight 0,6 g/set

Ungapped

Material	A_L value nH	μ_e	Ordering code
T38	4500 + 40/- 30 %	5680	B65523-J-Y38
N87	800 + 30/- 20 %	1000	B65523-J-R87



SMD coil former with gullwing terminals

Material: GFR liquid crystal polymer (UL 94 V-0, insulation class to IEC 60085:
F \geq max. operating temperature 155 °C), color code black

Solderability: to IEC 60068-2-20, test Ta, method 1 (aging 3): 350 °C, 1 s

Resistance to soldering heat: to IEC 60068-2-20, test Tb, method 1B: 350 °C, 3,5 s
permissible soldering temperature for wire-wrap connection on coil former: 400 °C, 1 s

Winding: see "Processing Notes", page 160

Yoke

Material: Stainless spring steel (0,1 mm)

Sections	A_N mm ²	l_N mm	A_R value $\mu\Omega$	Terminals	Ordering code
1	3,23	18,4	196	8	B65527-B1008-T1
Yoke					B65527-A2000

Coil former

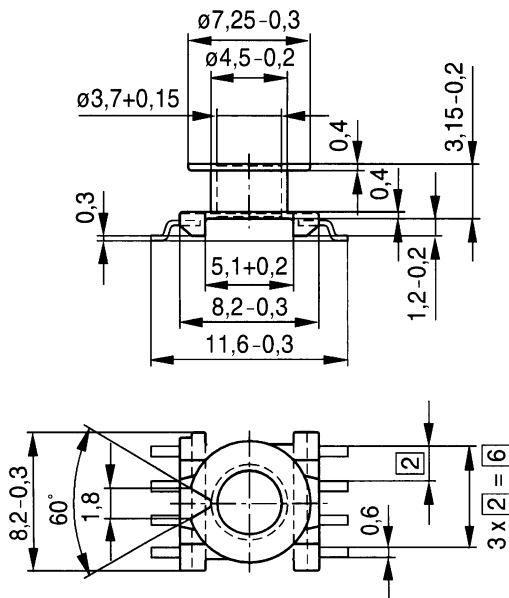

Yoke

