

**PLCC/RS-485/RF**  
 @500mA & 2A-20mS

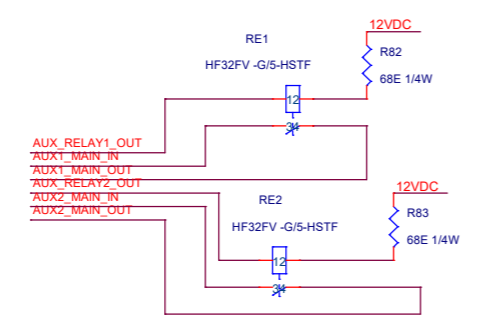

**AUXILIARY RELAYS**

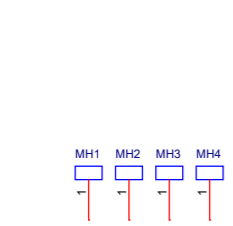
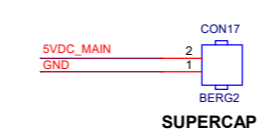
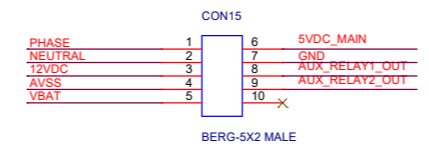
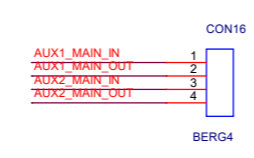

**SUPERCAP**

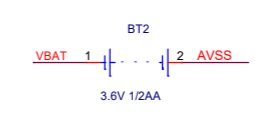

**BACKUP**

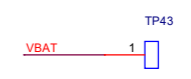

Title		
1P_SMART_EM_PS		
Size	Document Number	Rev
Custom	SEM_2_1	1.0
Date:	Thursday, July 21, 2022	Sheet 1 of 1