

Design Example Report

Title	<i>100 W USB PD 3.0 Power Supply with 3.3 V – 21 V / 5 A (100 W Power-limited) PPS Output Using InnoSwitch™ 3-PD PowiGaN™ INN3870C-H805 and HiperPFS-4 PFS7628C</i>
Specification	90 VAC – 265 VAC Input; 5 V / 5 A, 9 V / 5 A, 12 V / 5 A, 15 V / 5 A, 20 V / 5 A, or 3.3 V – 21 V / 5 A PPS (100 W Power-limited) Output
Application	USB PD / PPS Power Adapter
Author	Applications Engineering Department
Document Number	DER-937
Date	October 18, 2021
Revision	1.0

Summary and Features

- InnoSwitch3-PD: Off-Line CV/CC QR flyback switcher IC with integrated USB Type-C and USB-PD controller, integrated high-voltage switch, synchronous rectification and FluxLink™ feedback
 - Integrated USB Type-C and USB-PD controller reduces footprint, no external controller required
 - Comprehensive protection features with telemetry for power supply status and fault monitoring
- Meets DOE6 and CoC v5 2016 Average Efficiency requirements with at least 2.0% pass margin
 - 5 V Output: 92.10% at 115 VAC (7.11% margin); 91.47% at 230 VAC (6.48% margin)
 - 9 V Output: 92.60% at 115 VAC (3.75% margin); 92.77% at 230 VAC (3.91% margin)
 - 12 V Output: 92.64% at 115 VAC (3.64% margin); 93.17% at 230 VAC (4.17% margin)
 - 15 V Output: 91.87% at 115 VAC (2.87% margin); 91.97% at 230 VAC (2.97% margin)
 - 20 V Output: 91.30% at 115 VAC (2.20% margin); 91.32% at 230 VAC (2.32% margin)
- Meets CoC v5 2016 10% Load Efficiency requirements with high margin (>9.0%) for all PDOs
- <40 mW no-load input power at 230 VAC
- Meets CISPR22 / EN55022 Class B conducted EMI with high margin
 - >6dB margin at worst case condition (20 V / 5 A, 115 VAC)
- High power density: 15.0 W / inch³ without enclosure (3.30" x 2.17" x 0.93" form factor)
- Low component count: 121 total

Power Integrations

PATENT INFORMATION

The products and applications illustrated herein (including transformer construction and circuits external to the products) may be covered by one or more U.S. and foreign patents, or potentially by pending U.S. and foreign patent applications assigned to Power Integrations. A complete list of Power Integrations' patents may be found at www.power.com. Power Integrations grants its customers a license under certain patent rights as set forth at <https://www.power.com/company/intellectual-property-licensing/>.



Table of Contents

1	Introduction.....	7
2	Power Supply Specification.....	9
3	Schematic.....	11
4	Circuit Description	13
4.1	Input Rectifier and EMI Filter	13
4.2	HiperPFS-4 PFS7628C PFC Boost Converter	13
4.2.1	PFC Input Line Feed-Forward Sense Circuit	13
4.2.2	PFC Output Feedback Circuit.....	13
4.2.3	Bias Supply with Hysteresis Control to HiperPFS-4 IC	14
4.3	InnoSwitch3-PD IC Primary	15
4.4	InnoSwitch3-PD IC Secondary and USB Power Delivery Controller	16
5	PCB Layout.....	18
6	Bill of Materials	19
7	Common Mode Choke Specifications (L1)	21
7.1	Electrical Diagram.....	21
7.2	Electrical Specifications	21
7.3	Material List	21
7.4	Winding Instructions.....	21
8	PFC Inductor Specification (L4)	22
8.1	Electrical Diagram.....	22
8.2	Electrical Specifications	22
8.3	Inductor Build Diagram	22
8.4	Material List	23
8.5	Winding Instructions.....	23
9	Transformer Specification (T1)	25
9.1	Electrical Diagram.....	25
9.2	Electrical Specifications	25
9.3	Transformer Build Diagram.....	26
9.4	Material List	26
9.5	Winding Instructions.....	27
10	PFC Inductor Design Spreadsheet	35
11	Transformer Design Spreadsheet	40
11.1	Flyback Stage with PFC ON.....	40
11.2	Flyback Stage with PFC OFF	44
12	Performance Data.....	48
12.1	No-Load Input Power	48
12.2	Full Load Efficiency (On-board).....	49
12.3	Average and 10% Load Efficiency	49
12.3.1	Efficiency Requirements.....	49
12.3.2	Efficiency Performance Summary (On Board)	49
12.3.3	Average and 10% Load Efficiency Measurements.....	50
12.4	Efficiency Across Line at 100% Load (On Board)	53
12.5	Efficiency Across Load (On Board).....	54

12.5.1	Output: 5 V / 5 A	54
12.5.2	Output: 9 V / 5 A	55
12.5.3	Output: 12 V / 5 A	56
12.5.4	Output: 15 V / 5 A	57
12.5.5	Output: 20 V / 5 A	61
12.6	Load Regulation (On Board)	65
12.6.1	Output: 5 V / 5 A	65
12.6.2	Output: 9 V / 5 A	66
12.6.3	Output: 12 V / 5 A	67
12.6.4	Output: 15 V / 5 A	68
12.6.5	Output: 20 V / 5 A	69
12.7	Line Regulation (On Board)	70
12.7.1	Output: 5 V / 5 A	70
12.7.2	Output: 9 V / 5 A	71
12.7.3	Output: 12 V / 5 A	72
12.7.4	Output: 15 V / 5 A	73
12.7.5	Output: 20 V / 5 A	74
12.8	Input Current Harmonics.....	75
12.8.1	Output: 15 V / 5 A (115 VAC).....	75
12.8.2	Output: 15 V / 5 A (230 VAC).....	77
12.8.3	Output: 20 V / 5 A (115 VAC).....	79
12.8.4	Output: 20 V / 5 A (230 VAC).....	81
13	Thermal Performance.....	83
13.1	Thermal Performance in Open Case, Room Temperature	83
13.1.1	Output: 5 V / 5 A (90 VAC)	83
13.1.2	Output: 5 V / 5 A (265 VAC)	84
13.1.3	Output: 9 V / 5 A (90 VAC)	85
13.1.4	Output: 9 V / 5 A (265 VAC)	85
13.1.5	Output: 12 V / 5 A (90 VAC)	86
13.1.6	Output: 12 V / 5 A (265 VAC).....	86
13.1.7	Output: 15 V / 5 A (90 VAC)	87
13.1.8	Output: 15 V / 5 A (265 VAC).....	87
13.1.9	Output: 20 V / 5 A (90 VAC)	88
13.1.10	Output: 20 V / 5 A (265 VAC)	88
14	Waveforms.....	89
14.1	Input Voltage and Current Waveforms.....	89
14.1.1	Output: 15 V / 5 A	89
14.1.2	Output: 20 V / 5 A	89
14.2	PFC Inductor Current and HiperPFS-4 Drain Voltage Waveforms.....	90
14.2.1	Output: 15 V / 5 A	90
14.2.2	Output: 20 V / 5 A	90
14.3	Start-up Waveforms.....	91
14.3.1	Output Voltage and Current	91
14.3.2	Primary Drain Voltage and Current	92
14.3.3	SR FET Drain Voltage and Current	92

14.4	Primary Drain Voltage and Current (Steady-State).....	93
14.4.1	Output: 5 V / 5 A	93
14.4.2	Output: 9 V / 5 A	93
14.4.3	Output: 12 V / 5 A	94
14.4.4	Output: 15 V / 5 A	94
14.4.5	Output: 20 V / 5 A	95
14.5	SR FET Drain Voltage and Current (Steady-State).....	96
14.5.1	Output: 5 V / 5 A	96
14.5.2	Output: 9 V / 5 A	96
14.5.3	Output: 12 V / 5 A	97
14.5.4	Output: 15 V / 5 A	97
14.5.5	Output: 20 V / 5 A	98
14.6	Primary and SR FET Drain Voltage and Current (during Output Voltage Transition).....	99
14.6.1	Primary Drain Voltage and Current, 3.3 V to 21 V PPS Transition	99
14.6.2	SR FET Drain Voltage and Current, 3.3 V to 21 V Transition.....	100
14.7	Load Transient Response	101
14.7.1	Output: 5 V / 5 A	101
14.7.2	Output: 9 V / 5 A	102
14.7.3	Output: 12 V / 5 A	102
14.7.4	Output: 15 V / 5 A	103
14.7.5	Output: 20 V / 5 A	103
14.8	Output Ripple Measurements.....	104
14.8.1	Ripple Measurement Technique.....	104
14.8.2	Output Voltage Ripple Waveforms	105
14.8.3	Output Voltage Ripple Amplitude vs. Load.....	108
15	CV/CC Profile.....	113
15.1	Output: 20 V / 5 A PPS Request, PDO6 (100 W Power-Limited)	113
15.2	Output: 21 V / 5 A PPS Request, PDO6 (100 W Power-Limited)	114
16	Voltage Step and Current Limit Test using QuadraMAX and Total Phase Analyzer 115	
16.1	Voltage Step Test (VST)	115
16.2	Current Limit Test (CLT).....	116
17	Conducted EMI	117
17.1	Floating Ground (QPK / AV).....	117
17.1.1	Output: 5 V / 5 A	117
17.1.2	Output: 9 V / 5 A	118
17.1.3	Output: 12 V / 5 A	119
17.1.4	Output: 15 V / 5 A	120
17.1.5	Output: 20 V / 5 A	121
18	Combination Wave Surge	122
18.1	Differential Mode Surge (L1 to L2), 230 VAC Input	122
18.2	Common Mode Surge (L1, L2 to PE), 230 VAC Input.....	122
18.3	Common Mode Surge (L1 to PE), 230 VAC Input.....	122
18.4	Common Mode Surge (L2 to PE), 230 VAC Input	123

19	Electrostatic Discharge	124
19.1	VOUT and GND ESD Performance	124
19.1.1	Air Discharge, End of Cable, 230 VAC Input.....	125
19.1.2	Air Discharge, On-board, 230 VAC Input	126
19.1.3	Contact Discharge, End of Cable, 230 VAC Input	127
19.1.4	Contact Discharge, On the Board, 230 VAC Input.....	127
19.2	CC1 and CC2 ESD Performance.....	128
19.2.1	Air Discharge, End of cable, 230 VAC Input.....	129
19.2.2	Contact Discharge, End of Cable, 230 VAC Input	129
20	Revision History	130

Important Note:

Although this board is designed to satisfy safety isolation requirements, the engineering prototype has not been agency approved. Therefore, all testing should be performed using an isolation transformer to provide the AC input to the prototype board.

1 Introduction

This document is an engineering report describing a 100 W USB PD 3.0 power supply using InnoSwitch3-PD INN3870C-H805 for the flyback stage and HiperPFS-4 PFS7628C for the PFC front-end. The USB PD controller is integrated within the InnoSwitch3-PD IC, and the USB PD source capabilities of the power supply are listed below.

- PDO1: 5 V / 5 A (Fixed Supply)
- PDO2: 9 V / 5 A (Fixed Supply)
- PDO3: 12 V / 5 A (Fixed Supply)
- PDO4: 15 V / 5 A (Fixed Supply)
- PDO5: 20 V / 5 A (Fixed Supply)
- PDO6: 3.3 V – 21 V / 5 A (Programmable Power Supply, 100 W power-limited)

This design shows the high power density and efficiency that is possible due to the high level of integration of the InnoSwitch3-PD controller providing exceptional performance.

The report contains the power supply specification, schematic diagram, printed circuit board layout, bill of materials, magnetics specifications, and performance data.

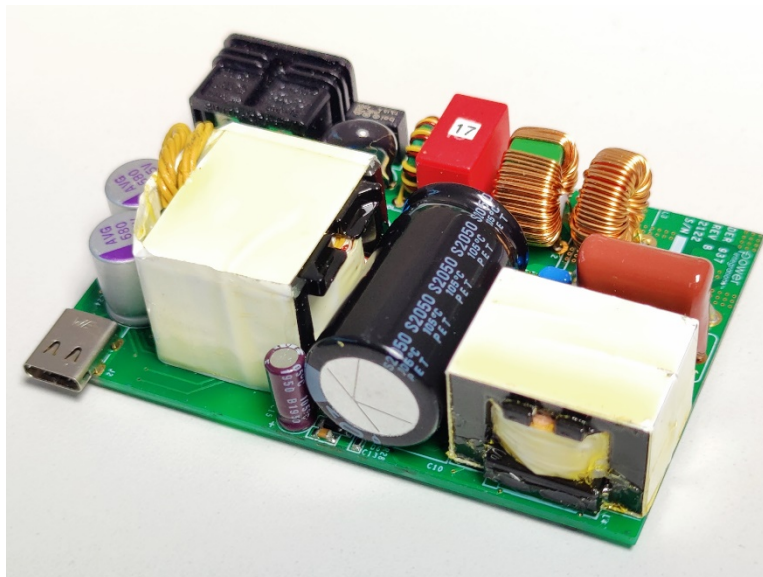

Figure 1 – Populated Circuit Board Photograph, Entire Assembly.

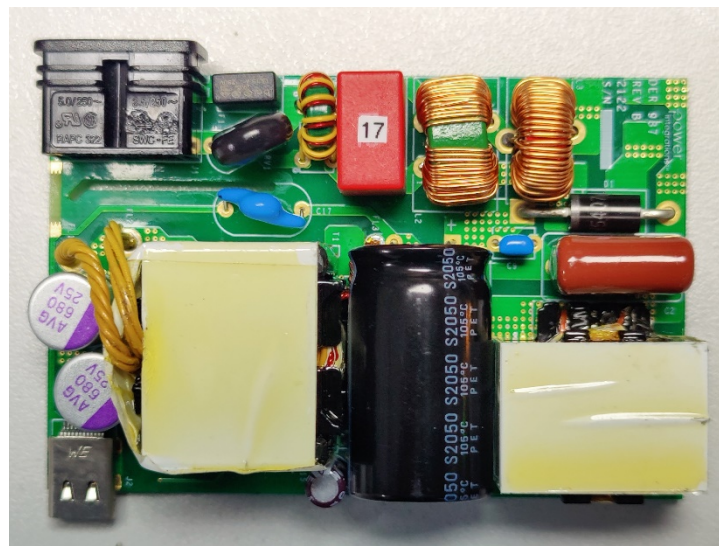

Figure 2 – Populated Circuit Board Photograph - Top.

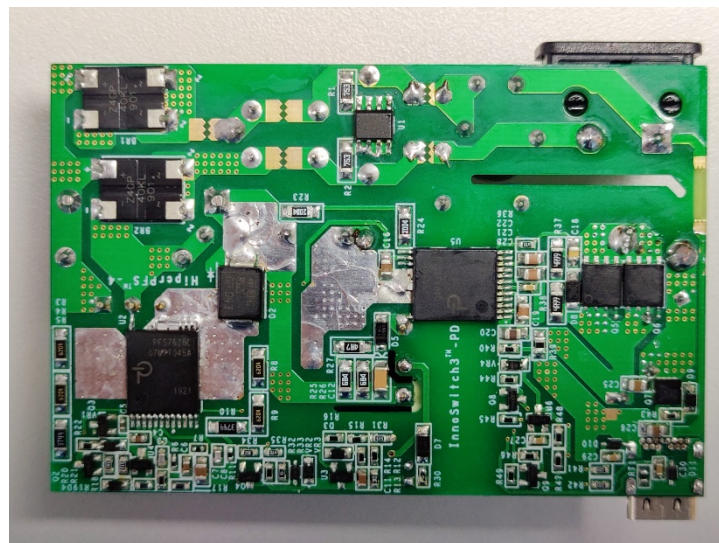

Figure 3 – Populated Circuit Board Photograph - Bottom.

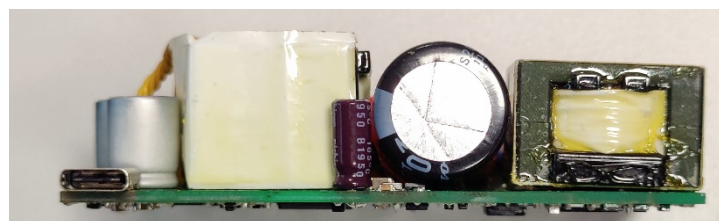

Figure 4 – Populated Circuit Board Photograph - Side.

2 Power Supply Specification

The table below represents the minimum acceptable performance of the design. Actual performance is listed in the results section.

Description	Symbol	Min	Typ	Max	Units	Comment
Input						
Input Voltage	V_{IN}	90		265	VAC	2 Wire – no P.E.
Input Frequency	f_{LINE}	47	50/60	64	Hz	
No-load Input Power				40	mW	Measured at 230 VAC
USB PD 3.0 Output: Fixed Supply PDOs						
5 V / 5 A Fixed Supply PDO1						
Output Voltage	$V_{OUT(5V)}$		5.0		V	See Note A.
Output Voltage Ripple	$V_{RIPPLE(5V)}$			125	mV	Measured at End of 100 mΩ Cable. See Note B.
Output Current	$I_{OUT(5V)}$			5.0	A	See Note C.
Average Efficiency	$\eta(5V)$	91.6			%	Average Efficiency at 115 VAC with VOUT Measured on the Board.
Continuous Output Power	$P_{OUT(5V)}$			25	W	
9 V / 5 A Fixed Supply PDO2						
Output Voltage	$V_{OUT(9V)}$		9.0		V	See Note A.
Output Voltage Ripple	$V_{RIPPLE(9V)}$			125	mV	Measured at End of 100 mΩ Cable. See Note B.
Output Current	$I_{OUT(9V)}$			5.0	A	See Note C.
Average Efficiency	$\eta(9V)$	92.1			%	Average Efficiency at 115 VAC with VOUT Measured on the Board.
Continuous Output Power	$P_{OUT(9V)}$			45	W	
12 V / 5 A Fixed Supply PDO3						
Output Voltage	$V_{OUT(12V)}$		12.0		V	See Note A.
Output Voltage Ripple	$V_{RIPPLE(12V)}$			125	mV	Measured at End of 100 mΩ Cable. See Note B.
Output Current	$I_{OUT(12V)}$			5.0	A	See Note C.
Average Efficiency	$\eta(12V)$	92.1			%	Average Efficiency at 115 VAC with VOUT Measured on the Board.
Continuous Output Power	$P_{OUT(12V)}$			60	W	
15 V / 5 A Fixed Supply PDO4						
Output Voltage	$V_{OUT(15V)}$		15.0		V	See Note A.
Output Voltage Ripple	$V_{RIPPLE(15V)}$			125	mV	Measured at End of 100 mΩ Cable. See Note B.
Output Current	$I_{OUT(15V)}$			5.0	A	See Note C.
Average Efficiency	$\eta(15V)$	91.3			%	Average Efficiency at 115 VAC with VOUT Measured on the Board.
Continuous Output Power	$P_{OUT(15V)}$			75	W	
20 V / 5 A Fixed Supply PDO5						
Output Voltage	$V_{OUT(20V)}$		20.0		V	See Note A.
Output Voltage Ripple	$V_{RIPPLE(20V)}$			125	mV	Measured at End of 100 mΩ Cable. See Note B.
Output Current	$I_{OUT(20V)}$			5.0	A	See Note C.
Average Efficiency	$\eta(20V)$	90.8			%	Average Efficiency at 115 VAC with VOUT Measured on the Board.
Continuous Output Power	$P_{OUT(20V)}$			100	W	

Description	Symbol	Min	Typ	Max	Units	Comment
USB PD 3.0 Output: Programmable Power Supply APDOs						
3.3 V – 21 V / 5 A PPS APDO6						
Programmable Output Voltage Range	V_{OUT(PDO6)}	3.3		21	V	APDO Minimum and Maximum Voltage. See Note A.
Programmable Output Current Limit Range	I_{OUT(PDO6)}	1.0		5.0	A	See Note D.
PPS Voltage Step	V_{STEP(PDO6)}		20		mV	PPS Voltage Step (USB PD 3.0).
PPS Current Step	I_{STEP(PDO6)}		50		mA	PPS Current Step (USB PD 3.0).
Continuous Output Power	P_{OUT(PDO6)}			100	W	PPS Power Limited bit = 1 (USB PD 3.0). See Note E.
Conducted EMI Margin		6			dB	Meets CISPR22B / EN55022B
Ambient Temperature	T_{AMB}	0		45	°C	Open Frame, Sea Level.

Note A: Output Voltage Regulation compliant with USB PD 3.0 Specifications.

B: Output Voltage Ripple measured at the end of 100 mΩ cable with the probe having decoupling capacitors 47 uF electrolytic and 100 nF ceramic in parallel.

C: Maximum Operating Current for the Fixed Supply PDO. Output Over Current Protection Threshold nominally set at 250 mA above the Operating Current requested by the USB PD Sink.

D: Output Current Limit Accuracy is within ±150 mA for Operating Current between 1 A and 3 A, or ±5% for Operating Current > 3 A; compliant with USB PD 3.0 Specifications.

E: For PPS APDOs with Power Limited bit set to 1, whenever the USB PD Sink sends a valid Output Voltage and Current Limit request that exceeds 100 W, the power supply will provide the requested output voltage and an output current limit that matches 100 W maximum output power.

Note: To use this design for a charger/adaptor with a different shape and form factor, the changes in the circuit board layout must be carefully evaluated to meet the target specifications for EMI, ESD, and Line Surge performance.

3 Schematic

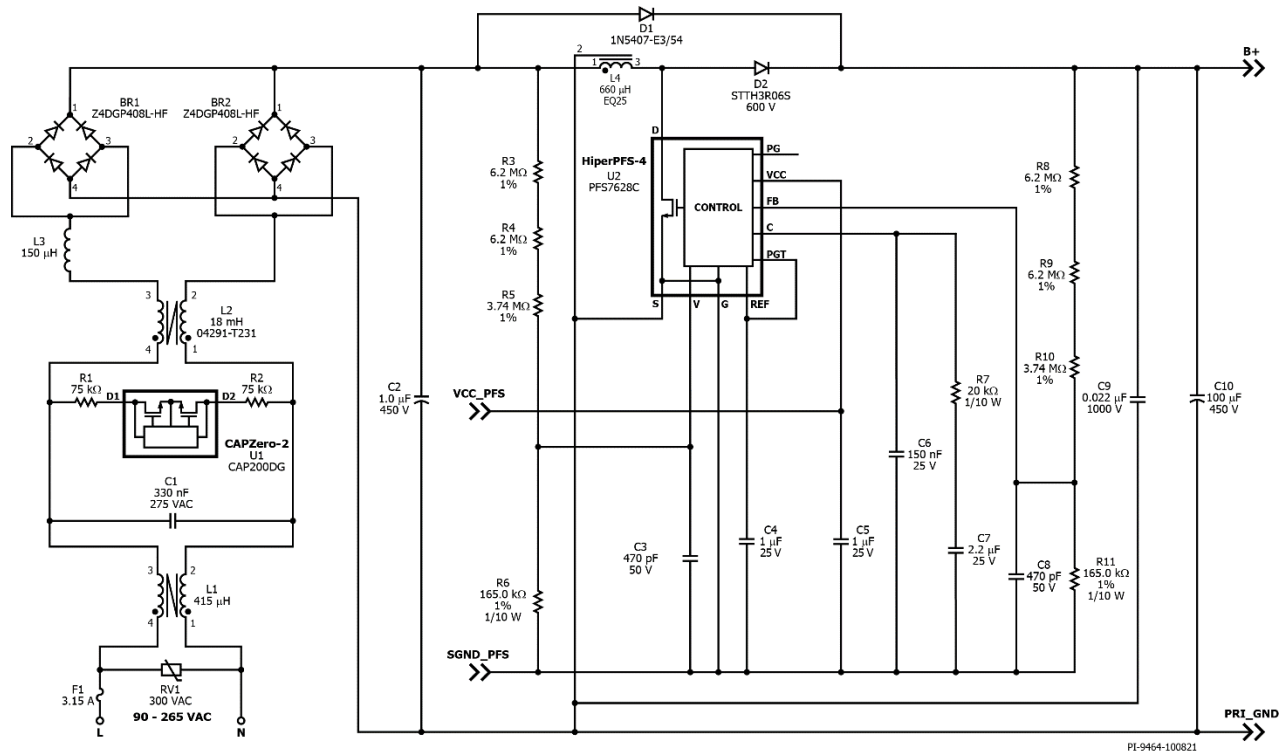

Figure 5 – DER-937 Rev B Schematic – PFC Section.

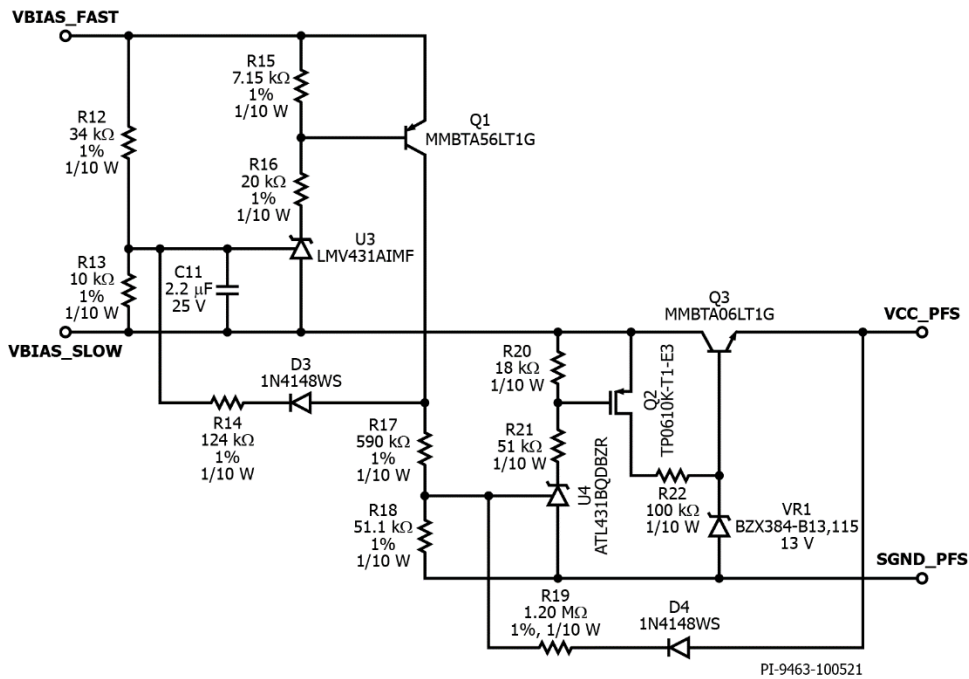

Figure 6 – DER-937 Rev B Schematic – PFC Bias Supply Control Circuit.

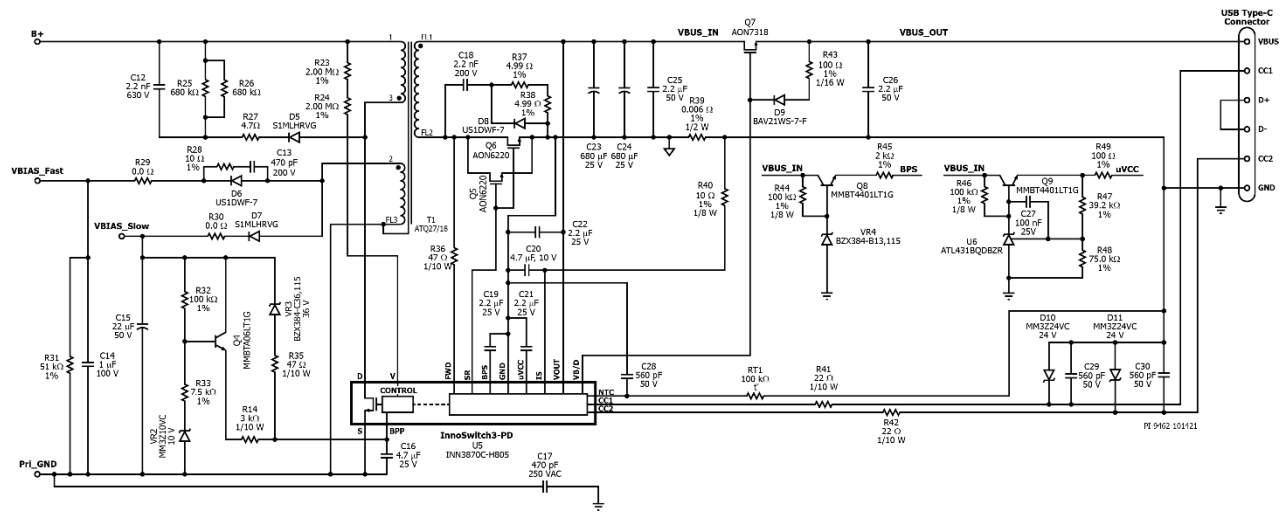

Figure 7 – DER-937 Rev B Schematic – Flyback Section.

4 Circuit Description

4.1 *Input Rectifier and EMI Filter*

The input fuse F1 isolates the circuit and provides protection from component failure. Metal oxide varistor RV1 offers protection during line surge events by effectively clamping the input voltage seen by the power supply. Common mode chokes L1 and L2, differential mode choke L3, along with capacitors C17, C1, and C2 provide common mode and differential mode noise filtering for EMI attenuation. Bridge rectifiers BR1 and BR2 rectifies the AC line voltage to have a full wave rectified DC.

The CAPZero-2 IC U1 with resistors R1 and R2 discharge the stored energy in capacitor C1 when the power supply is disconnected from AC mains. The CAPZero-2 IC eliminates static losses in R1 and R2 by only connecting these components across C1 when AC input is removed.

4.2 *HiperPFS-4 PFS7628C PFC Boost Converter*

The PFC boost converter power stage consists of the HiperPFS-4 IC U2, boost inductor L4, ultrafast diode D2, and output filter capacitor C10. With an active PFC boost converter as a front-end stage of the power supply, a sinusoidal input current with low harmonic content is maintained while having a regulated DC voltage to the flyback DC-DC converter stage of the power supply.

Diode D1 acts as a pre-charge diode, preventing a resonant build-up of output voltage during start-up by bypassing L4 while simultaneously charging C10.

Capacitor C9 provides a short, high-frequency return path from PFC output B+ to primary ground RTN for improved EMI performance and reduce voltage overshoot across the MOSFET drain-source inside U2 at each turn-off edge.

HiperPFS-4 IC U2 is configured in full power mode by capacitor C4 which is connected to the REF pin.

4.2.1 PFC Input Line Feed-Forward Sense Circuit

The rectified DC voltage at the PFC input is sensed by HiperPFS-4 IC U2 using resistors R3-R6. These resistors have large values to minimize power consumption. The resistor values are also matched with the FEEDBACK pin resistor divider network for optimized power factor performance. Capacitor C3 filters noise coupled into the VOLTAGE MONITOR pin.

4.2.2 PFC Output Feedback Circuit

Output voltage divider network comprising of resistors R8-R11 are used to scale the output voltage and provide feedback to the IC. The resistor values are set to have a PFC output voltage of 380 V. Capacitor C8 filters noise coupled into the FEEDBACK pin.

Components R7, C6, and C7 are required for shaping the loop response of the feedback network.

4.2.3 Bias Supply with Hysteresis Control to HiperPFS-4 IC

The HiperPFS-4 IC requires a regulated VCC supply of 12 V nominal for normal operation, with an absolute maximum voltage of 15 V. Capacitor C5 provides noise filtering to the VCC pin. Bringing the VCC pin voltage below the shutdown VCC voltage threshold will trigger an undervoltage lock-out protection and disable switching of the HiperPFS-4 device.

The PFC bias supply is derived from the flyback stage auxiliary output as shown previously in Figure 8. From a single bias winding, two rectified and filtered voltages are created: (1) VBIAS_Fast generated using US1DWF-7 ultrafast recovery diode D6, RC snubber R28 and C13, series resistor R29, filter capacitor C14, and shunt resistor R31; and (2) VBIAS_Slow generated using S1MLHRVG standard recovery diode D7, series resistor R30, and filter capacitor C15.

Any of the two voltages, VBIAS_Fast and VBIAS_Slow, can be used to estimate the flyback converter output voltage. Moreover, the voltage difference between VBIAS_Fast and VBIAS_Slow provide a signal which increases as flyback output current increases. Therefore, this voltage difference, VBIAS_delta, can also be used to estimate the flyback converter output current. The HiperPFS-4 VCC pin voltage is controlled such that the PFC stage is operational when the power supply input power is 75 W or higher, and the PFC stage is disabled when the load current is equal to or less than 10% of rated I_{OUT} . This control scheme results in significantly high efficiency at light load (10% and below) for all supported output voltage settings as compared to when both PFC stage and flyback stage are operational.

The PFC bias supply circuit monitors VBIAS_Fast and VBIAS_Slow as previously shown in Figure 6. The first stage consists of the following: LMV431 IC U3 functions as a comparator, resistor divider R12 and R13 sets turn on threshold of U3, capacitor C11 filters the input terminal of U3, resistors R15 and R16 provide bias to PNP BJT Q1 when comparator U3 turns on, and diode D3 and resistor R14 provide hysteresis. Whenever VBIAS_delta (estimate of output current) exceeds 5.25 V typical, Q1 will turn on and VBIAS_Fast (estimate of output voltage) will be monitored by the second stage of the PFC bias supply circuit. VBIAS_delta turn off threshold of 4.65 V typical is set using D3 and R14 to prevent turn on/off chatter.

Similarly, the PFC bias circuit second stage consists of the following: ATL431 IC U4 functions as a comparator, resistor divider R17 and R18 sets turn on threshold of U4, resistors R20 and R21 provide bias to P-channel MOSFET Q2, diode D4 and resistor R19 provide hysteresis, and a linear regulator formed by resistor R22, Zener diode VR1, and NPN transistor Q3 provides either 12.4 V or 0 V to the HiperPFS-4 IC VCC pin depending on Q2 state. Whenever the first stage is at on-state (output current exceeds threshold) and VBIAS_Fast exceeds 31.4 V typical, Q2 will turn on and effectively enable the PFC

stage of the power supply. VBIAS_Fast turn off threshold of 26.4 V typical is set with D4 and R19 to prevent turn on/off chatter.

The PFC bias supply circuit uses VBIAS_Fast and VBIAS_Slow signals in the flyback primary-side as indirect estimates of output voltage and current in the flyback secondary-side. The corresponding flyback output voltage and current at which the PFC turns on varies with AC input voltage because the peak-charging of the fast bias filter capacitor C14 differs from low-line to high-line. When operating at a fixed output voltage, the output current threshold for PFC turn-off is practically independent on AC input voltage since the flyback stage will be operating at 380 VDC input. Slight changes in PFC turn on/off thresholds is also expected across a wide operating ambient temperature or when the effective transformer leakage inductance is changed (for example, inserting a wire loop on the secondary-side for current probe to measure SR FET drain current waveform).

The bias diode reverse recovery values, RC snubber values, resistance ratios and values, and amount of hysteresis have been tuned in this power supply such that the variations mentioned above are reduced. The resulting performance data are presented in Section 12 of this document.

4.3 *InnoSwitch3-PD IC Primary*

One end of the flyback transformer T1 primary winding is connected to the PFC stage output capacitor and the other end is connected to the drain terminal of the switch inside the InnoSwitch3-PD IC U5. Resistors R23 and R24 provide input voltage sensing for protection in case of AC input undervoltage or overvoltage.

A low-cost RCD clamp formed by diode D5, resistors R25, R26, and R27, and capacitor C12 limits the peak drain-source voltage of U5 at the instant the switch inside U5 turns off. The clamp helps to dissipate the energy stored in the leakage reactance of transformer T1.

The IC is self-starting, using an internal high-voltage current source to charge the BPP pin capacitor C16 when AC is first applied. During normal operation, the primary side block is powered from an auxiliary winding on the transformer T1. VBIAS_Slow, which is the filtered supply voltage using the auxiliary winding, diode rectifier D7, series resistor R30, and filter capacitor C15, is used to power the InnoSwitch3-PD primary-side. A linear regulator comprising resistor R32, R33, BJT Q4 and Zener diode VR2 ensures sufficient current flows through R34 into the BPP pin of the InnoSwitch3-PD IC such that the internal current source of U5 is not required to charge C16 to minimize power consumption during no-load condition and at normal operation.

Zener diode VR3 offers primary sensed output overvoltage protection. In a flyback converter, output of the auxiliary winding tracks the output voltage of the converter. In case of overvoltage at output of the converter, the auxiliary winding voltage increases and causes breakdown of VR3 which then causes excess current to flow into the BPP pin of InnoSwitch3-PD IC. If the current flowing into the BPP pin increases above the I_{SD}

threshold, the InnoSwitch3-PD controller will latch off and prevent any further increase in output voltage. Resistor R35 limits the current injected to BPP pin when the output overvoltage protection is triggered.

4.4 *InnoSwitch3-PD IC Secondary and USB Power Delivery Controller*

The secondary-side of the InnoSwitch3-PD IC provides output voltage and current sensing and a gate drive to a FET for synchronous rectification. The voltage across the transformer secondary winding is rectified by the secondary-side synchronous rectifier FET (SR FET) Q5 and Q6 and filtered by capacitors C23, C24, and C25. High frequency ringing during switching transients that would otherwise create radiated EMI is reduced via a RCD snubber, R37, R38, C18, and D8.

The gate of Q5 and Q6 is turned on by secondary-side controller inside IC U1, based on the secondary winding voltage sensed via resistor R36 and fed into the FWD pin of the IC.

In continuous conduction mode of operation, the SR FET is turned off just prior to the secondary-side commanding a new switching cycle from the primary. In discontinuous mode of operation, the SR FET is turned off when the magnitude of the voltage drop across the SR FET falls below a threshold of approximately $V_{SR(TH)}$. Secondary-side control of the primary-side power switch avoids any possibility of cross conduction of the two switches and provides extremely reliable synchronous rectifier operation.

The secondary-side of the IC is self-powered from either the secondary winding forward voltage or the output voltage. Capacitor C19 connected to the BPS pin of InnoSwitch3-PD IC provides decoupling for the internal circuitry. An external supply circuit from the flyback output voltage to BPS pin is formed by NPN BJT Q8, Zener diode VR4, and resistors R44 and R45. When the output voltage exceeds VR4 breakdown voltage, current is injected through this circuit to reduce the power dissipation of the regulator inside the InnoSwitch3-PD IC, effectively improving the IC temperature.

The output current is sensed by monitoring the voltage drop across resistor R39. The current measurement is filtered with resistor R40 and capacitor C20, and then monitored across the IS and SECONDARY GROUND pins. An internal current sense threshold which is configured via the integrated secondary and USB PD controllers of InnoSwitch3-PD IC up to approximately 32 mV is used to reduce losses. Once the threshold is exceeded, the InnoSwitch3-PD IC uses variable frequency and variable primary switch peak current limit control schemes to maintain a fixed output current.

For constant current (CC) operation, when the output voltage falls, the secondary-side controller inside InnoSwitch3-PD IC will power itself from the secondary winding directly. During the on-time of the primary-side power switch, the forward voltage that appears across the secondary winding is used to charge the SECONDARY BYPASS pin decoupling capacitor C19 via resistor R36 and an internal regulator. This allows output current

regulation to be maintained down to the minimum UV threshold. Below this level the unit enters auto-restart until the output load is reduced.

When the output current is below the CC threshold, the converter operates in constant voltage mode. The output voltage is monitored by the VOUT pin of the InnoSwitch3-PD IC. Similar with current regulation, the output voltage is also compared to an internal voltage threshold that is set via the integrated secondary and USB PD controllers of the InnoSwitch3-PD IC and output voltage regulation is achieved by variable frequency and variable primary switch peak current limit control schemes. Capacitor C22 is needed between the VOUT pin and the SECONDARY GROUND pin for ESD protection of the VOUT pin.

N-channel MOSFET Q7 functions as the bus switch which connects or disconnects the output of the flyback converter from the USB Type-C receptacle. MOSFET Q7 is controlled by the VB/D pin on the InnoSwitch3-PD IC. Resistor R43 and diode D9 are connected across the Source and Gate terminals of the Q7 to provide a discharge path for the bus voltage when the Q7 is turned off. Capacitor C26 is used at the output for ESD protection and output voltage ripple reduction.

The USB Power Delivery (USB PD) controller is integrated within the InnoSwitch3-PD IC. Capacitor C21 connected to uVCC pin serves as a decoupling capacitor. An external precision supply circuit from the flyback output voltage to uVCC pin is formed by NPN BJT Q9, shunt regulator IC U6, resistors R46-R49, and capacitor C27. Current is injected through this circuit to reduce the power dissipation of the regulator inside the InnoSwitch3-PD IC especially at high operating output voltage, effectively improving the IC temperature. When the output voltage is below approximately 4.4 V, the external circuit will not supply current into the uVCC pin and the USB PD controller will be powered through the internal regulator of the InnoSwitch3-PD IC.

USB PD protocol is communicated through either CC1 or CC2 line depending on the orientation in which the Type-C plug is connected. Capacitors C29 and C30, resistors R41 and R42, and Zener diodes D10, and D11 provide protection from ESD to pins CC1 and CC2.

5 PCB Layout

Layers: Two (2)

Board Material: FR4

Copper Weight: 2 oz

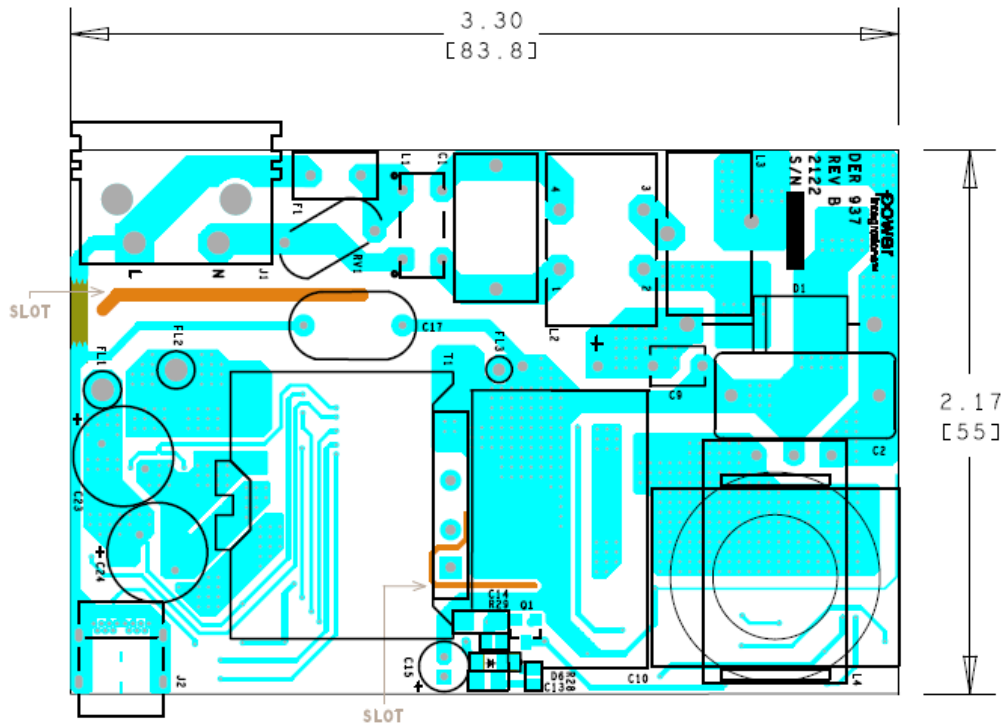

Figure 8 – DER-937 RevB PCB Layout, Top.

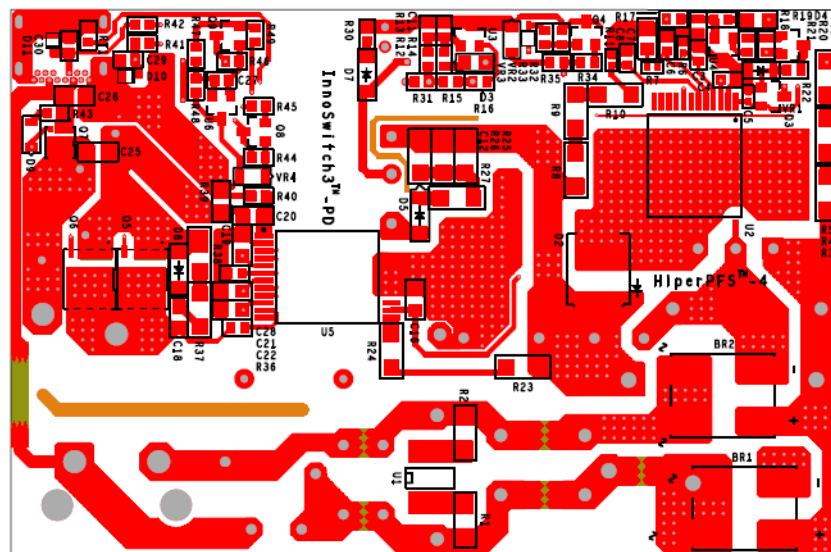

Figure 9 – DER-937 RevB PCB Layout, Bottom.

6 Bill of Materials

Item	Qty	Ref Des	Description	Mfg Part Number	Mfg
1	2	BR1 BR2	RECT BRIDGE, GP, 800 V, 4 A, Z4-D	Z4DGP408L-HF	Comchip
2	1	C1	330 nF, ±10%, 275 VAC, Polypropylene Film, X2, 15.00 mm x 8.50 mm	890324024003CS	Würth
3	1	C2	1.0 µF, 450 V, Polyester Film	ECQ-E2W105KH	Panasonic
4	2	C3 C8	470 pF 50 V, Ceramic, COG/NP0, 0603	VJ0603A471JXAAC	Vishay
5	1	C4	1 µF, ±10%, 25 V, Ceramic, X7R, 0603	CGA3E1X7R1E105K080AE	TDK
6	1	C5	1 µF 25 V, Ceramic, X5R, 0402	TMK105BJ105MV-F	Taiyo Yuden
7	1	C6	0.15 µF, ±10%, 25 V, Ceramic, X7R, 0603	GCM188R71E154KA37D	Murata
8	4	C7 C19 C21 C22	2.2 µF, ±10%, 25 V, X7R, r, -55 °C ~ 125 °C, 0805	CL21B225KAFVPNE	Samsung
9	1	C9	0.022 µF, ±10%, 1 kV, X7R, Radial, -55 °C ~ 125 °C, 0.217" L x 0.157" W (5.50 mm x 4.00 mm)	RDER73A223K3M1H03A	Murata
10	1	C10	100 µF, ±20%, 450 V, Electrolytic, (18 x 30)	450BXW100MEFR18X30	Rubycon
11	1	C11	2.2 µF, ±10%, 25 V, Ceramic, X7R, 0603, -55 to 125 °C	GRM188Z71E225KE43D	Murata
12	1	C12	2.2 nF, 630 V, Ceramic, X7R, 1206	C3216X7R2J222K115AA	TDK
13	1	C13	470 pF, 200 V, Ceramic, X7R, 0805	C0805C471K2RACTU	Kemet
14	1	C14	1 µF, 100 V, Ceramic, X7R, 1206	HMK316B7105KL-T	Taiyo Yuden
15	1	C15	22 µF, 50 V, Electrolytic, (5 x 11)	UPW1H220MDD	Nichicon
16	1	C16	4.7 µF ±10%, 25 V, X7R, 0805, -55 °C ~ 125 °C	TMK212AB7475KG-T	Taiyo Yuden
17	1	C17	470 pF, ±10%, 250 VAC, X1, Y1, Ceramic, B, Radial, Disc	DE1B3RA471KA4BN01F	Murata
18	1	C18	2.2 nF, 200 V, Ceramic, X7R, 0805	08052C222KAT2A	AVX
19	1	C20	4.7 µF, 10 V, Ceramic, X5R, 0805	C0805C475K8PACTU	Kemet
20	2	C23 C24	680 µF, ±20%, 25V, Aluminum Polymer Radial, Can, 292.56 mΩ, 1500 Hrs @ 125°C, (10 x 13.5)	687AVG025MGBJ	Illinois Capacitor
21	2	C25 C26	2.2 µF, ±10%, 50 V, Ceramic, X7R, 0805	UMK212BB7225KG-T	Taiyo Yuden
22	1	C27	100 nF, 0.1 µF, ±10%, 25 V, Ceramic, X7R, General Purpose, -55 °C ~ 125 °C, 0603	CL10B104KA8NFNC	Samsung
23	3	C28 C29 C30	560 pF, 50 V, Ceramic, X7R, 0603, 0.063" L x 0.031" W (1.60 mm x 0.80 mm)	CC0603KRX7R9BB561	Yageo
24	1	D1	800 V, 3 A, Rectifier, DO-201AD	1N5407-E3/54	Vishay
25	1	D2	600 V, 3 A, SMC, DO-214AB	STTH3R06S	ST Micro
26	2	D3 D4	Diode, GEN PURP, 75 V 150 mA, SOD323	1N4148WS-7-F	Diodes, Inc.
27	2	D5 D7	Diode, Standard, 1000 V, 1 A, SMT, Sub SMA	S1MLHRVG	Taiwan Semi
28	2	D6 D8	Diode, Ultra-Fast Recovery, 200 V, 1 A, SOD-123F, SOD123FL, SOD-123F-2	US1DWF-7	Diodes, Inc.
29	1	D9	250 V, 0.2 A, Fast Switching, 50 ns, SOD-323	BAV21WS-7-F	Diodes, Inc.
30	2	D10 D11	Diode, Zener, 24 V, 200 mW, SC-90, SOD-323F	MM3Z24VC	ON Semi
31	1	F1	3.15 A, 250 V, Slow, RST	507-1181	Belfuse
32	1	J1	Power Entry Connector Receptacle, Male Pins, IEC 320-C8, Non-Polarized, Panel Mount, Snap-In; TH, RA	RAPC322X	Switchcraft
33	1	J2	Connector, "Certified", USB - C, USB 3.1, For 0.062" PCB Material, Superspeed+, Receptacle Connector, 24 Pos, SMT, RA, TH	632723300011	Würth
34	1	L1	Toroidal CMC, 415 µH, ±30%, CUSTOM, DER-937, Wound on 32-00330-00 core.	32-00413-00	Power Integrations
35	1	L2	Custom, CMC, 18 mH @ 10 kHz, Toroidal, 17.5 mm OD x 11.0 mm thick. 40 turns x 2, 0.40 mm wire 190 mΩ max	04291-T231	Sumida
36	1	L3	150 µH, 20%, 2.5 A, Rdc=0.01, INDUCTOR, TOROID, HI AMP, VERT, 16.5 mm Diam, 8.5 mm Thick, 8.5 mm LS	7447018	Würth
37	1	L4	Custom, DER-937 PFC Inductor, EQ25, 660 µH		Power Integrations
38	1	Q1	PNP, Small Signal BJT, 80 V, 0.5 A, SOT-23	MMBTA56LT1G	On Semi
39	1	Q2	60 V, 0.185 A, P-Channel, SOT 23-3	TP0610K-T1-E3	Vishay
40	2	Q3 Q4	NPN, Small Signal BJT, 80 V, 0.5 A, SOT-23	MMBTA06LT1G	On Semi



41	2	Q5 Q6	MOSFET, N-CH, 100 V, 48 A (Tc), 113.5 W (Tc), DFNSX6, 8-DFN (5x6)	AON6220	Alpha & Omega Semi
42	1	Q7	N-Channel 30 V 36.5 A (Ta), 50 A (Tc) 4.1W (Ta), 39W (Tc) SMT 8-DFN-EP (3.3x3.3), 8DFN, 8-PowerVDFN	AON7318	Alpha & Omega Semi
43	2	Q8 Q9	NPN, Small Signal BJT, GP, 40 V, 600 mA, 250 MHz, 300 mW, SOT-23, SOT-23-3 (TO-236)	MMBT4401LT3G	On Semi
44	2	R1 R2	RES, 75 k Ω , 5%, 1/4 W, Thick Film, 1206	ERJ-8GEYJ753V	Panasonic
45	4	R3 R4 R8 R9	RES, 6.2 M Ω , 1%, 1/4 W, Thick Film, 1206	KTR18EZPF6204	Rohm Semi
46	2	R5 R10	RES, 3.74 M Ω , 1%, 1/4 W, Thick Film, 1206	CRCW12063M74FKEA	Vishay
47	2	R6 R11	RES, 165.0 k Ω , 1%, 1/10 W, Thick Film, 0402	ERJ-2RKF1653X	Panasonic
48	1	R7	RES, 20 k Ω , 5%, 1/10 W, Thick Film, 0402	ERJ-2GEJ203X	Panasonic
49	1	R12	RES, 34 k Ω , 1%, 1/10 W, Thick Film, 0603	ERJ-3EKF3402V	Panasonic
50	1	R13	RES, 10.0 k Ω , 1%, 1/10 W, Thick Film, 0603	ERJ-3EKF1002V	Panasonic
51	1	R14	RES, 124 k Ω , 1%, 1/10 W, Thick Film, 0603	ERJ-3EKF1243V	Panasonic
52	1	R15	RES, 7.15 k Ω , 1%, 1/10 W, Thick Film, 0603	ERJ-3EKF7151V	Panasonic
53	1	R16	RES, 20 k Ω , 1%, 1/10 W, Thick Film, 0603	ERJ-3EKF2002V	Panasonic
54	1	R17	RES, 590 k Ω , 1%, 1/10 W, Thick Film, 0603	ERJ-3EKF5903V	Panasonic
55	1	R18	RES, 51.1 k Ω , 1%, 1/10 W, Thick Film, 0603	ERJ-3EKF5112V	Panasonic
56	1	R19	RES, 1.20 M Ω , 1%, 1/10 W, Thick Film, 0603	ERJ-3EKF1204V	Panasonic
57	1	R20	RES, 18 k Ω , 5%, 1/10 W, Thick Film, 0603	ERJ-3GEYJ183V	Panasonic
58	2	R21 R31	RES, 51 k Ω , 5%, 1/10 W, Thick Film, 0603	ERJ-3GEYJ513V	Panasonic
59	4	R22 R32 R44 R46	RES, 100 k Ω , 5%, 1/10 W, Thick Film, 0603	ERJ-3GEYJ104V	Panasonic
60	2	R23 R24	RES, 2.00 M Ω , 1%, 1/4 W, Thick Film, 1206	ERJ-8ENF2004V	Panasonic
61	2	R25 R26	RES, 680 k Ω , 5%, 1/4 W, Thick Film, 1206	ERJ-8GEYJ684V	Panasonic
62	1	R27	RES, 4.7 Ω , 5%, 1/4 W, Thick Film, 1206	ERJ-8GEYJ4R7V	Panasonic
63	2	R28 R40	RES, 10 Ω , 1%, 1/10 W, Thick Film, 0603	ERJ-3EKF10R0V	Panasonic
64	2	R29 R30	RES, 0 Ω , 5%, 1/10 W, Thick Film, 0603	ERJ-3GEY0R00V	Panasonic
65	1	R33	RES, 7.5 k Ω , 1%, 1/10 W, Thick Film, 0603	ERJ-3EKF7501V	Panasonic
66	1	R34	RES, 3 k Ω , 5%, 1/10 W, Thick Film, 0603	ERJ-3GEYJ302V	Panasonic
67	2	R35 R36	RES, 47 Ω , 5%, 1/10 W, Thick Film, 0603	ERJ-3GEYJ470V	Panasonic
68	2	R37 R38	4.99 Ω , \pm 1%, 1/4 W Chip Resistor, 1206, Moisture Resistant, Thick Film	RC1206FR-074R99L	Yageo
69	1	R39	RES, 0.006 Ω , \pm 1%, 1/2 W, 805, Current Sense, Thick Film, \pm 300ppm/ $^{\circ}$ C, -55 $^{\circ}$ C ~ 155 $^{\circ}$ C	ERJ-6LWFR006V	Panasonic
70	2	R41 R42	RES, 22 Ω , 5%, 1/10 W, Thick Film, 0603	ERJ-3GEYJ220V	Panasonic
71	2	R43 R49	RES, 100 Ω , 1%, 1/10 W, Thick Film, 0603	ERJ-3EKF1000V	Panasonic
72	1	R45	RES, 2 k Ω , 1%, 1/10 W, Thick Film, 0603	ERJ-3EKF2001V	Panasonic
73	1	R47	RES, 39.2 k Ω , 1%, 1/10 W, Thick Film, 0603	ERJ-3EKF3922V	Panasonic
74	1	R48	RES, 75.0 k Ω , 1%, 1/10 W, Thick Film, 0603	ERJ-3EKF7502V	Panasonic
75	1	RT1	NTC Thermistor, 100 k Ω , 1%, 4250 K, 0603	NCU18WF104F60RB	Murata
76	1	RV1	300 VAC, 60 J, 10 mm, RADIAL	ERZ-V10D471	Panasonic
77	1	T1	Custom, DER-937 Transformer ATQ27/18.4, Lp = 560 μ H.		Power Integrations
78	1	U1	CAPZero-2, SO-8C	CAP200DG	Power Integrations
79	1	U2	HiperPFS-4, InSOP24B	PFS7628C	Power Integrations
80	1	U3	1.24 V Shunt Regulator IC, 1%, -40 to 85 C, SOT23-3	LMV431AIMF/NOPB	Texas Instruments
81	2	U4 U6	IC, VREF, SHUNT, 36 V, 0.5%, 82ppm/ $^{\circ}$ C, -40 $^{\circ}$ C ~ 125 $^{\circ}$ C (TA), SOT23-3, TO-236-3, SC-59, SOT-23-3	ATL431BQDBZR	Texas Instruments
82	1	U5	InnoSwitch3-PD, InSOP24D	INN3870C-H805	Power Integrations
83	2	VR1 VR4	13 V, 2%, 300 mW, SOD-323	BZX384-B13,115	NXP Semi
84	1	VR2	Diode, Zener, 10 V, 200 mW, \pm 5%, SOD323F,SC-90	MM3Z10VC	ON Semi
85	1	VR3	Diode Zener 36 V 300 mW SOD323	BZX384-C36,115	Nexperia

Total component count: 121



7 Common Mode Choke Specifications (L1)

7.1 Electrical Diagram

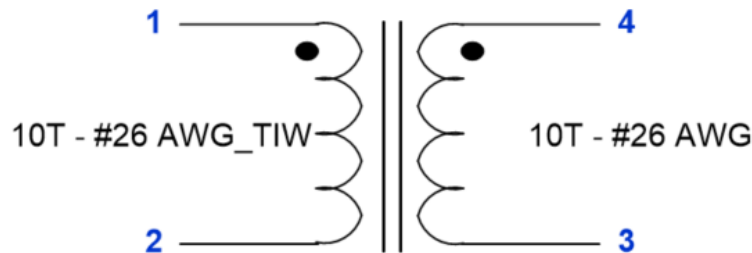

Figure 10 – Inductor Electrical Diagram.

7.2 Electrical Specifications

Inductance	Across pin 1 to pin 2 (or pin 4 to pin 3) with the other winding open. LCR meter L_s measurement, 100 kHz switching frequency, 1.0 V test level.	415 μ H $\pm 30\%$
DC Resistance	Across pin 1 to pin 2 (or pin 4 to pin 3) with the other winding open.	45 m Ω (Max.)

7.3 Material List

Item	Description
[1]	Core, Ferrite Inductor Toroid, 9 mm OD x 5 mm ID x 3mm H. AL = 4150 nH/N ² $\pm 30\%$ PI#: 32-00330-00.
[2]	Magnet Wire: #26 AWG, Triple Insulated Wire.
[3]	Magnet Wire: #26 AWG, Double Coated.
[4]	Varnish: Dolph BC-359.

7.4 Winding Instructions

	<p>Start as pin 1 for Item [2] and pin 4 for Item [3].</p> <p>Wind together 10 turns to core Item [1].</p> <p>Mark end of Item [2] as pin 2 and end of Item [3] as pin 3.</p> <p>Cut the wires with practically short length remaining (~2 inch each) such the CMC can be easily populated into the PCB.</p> <p>Varnish the CMC using Item [4].</p> <p>Cut excess wire when soldering into the PCB.</p>
--	---

8 PFC Inductor Specification (L4)

8.1 Electrical Diagram

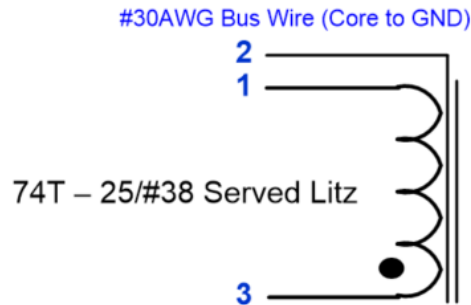

Figure 11 – PFC Inductor Electrical Diagram.

8.2 Electrical Specifications

Inductance	Measured across pin 1 to pin 3. LCR meter L_s measurement, 100 kHz switching frequency, 1.0 V test level.	660 $\mu\text{H} \pm 7\%$
-------------------	---	---------------------------

8.3 Inductor Build Diagram

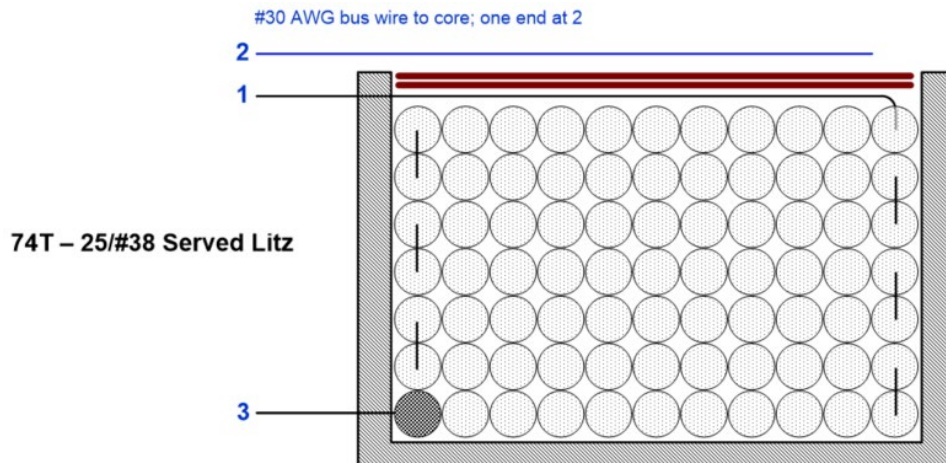
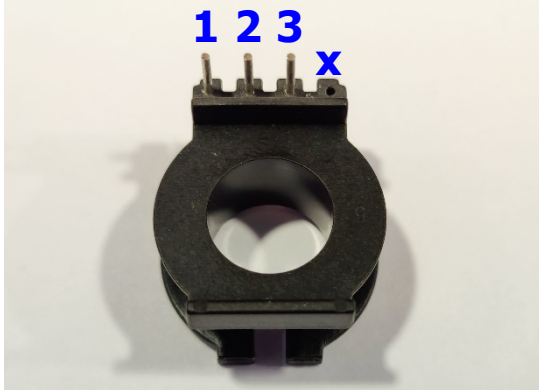
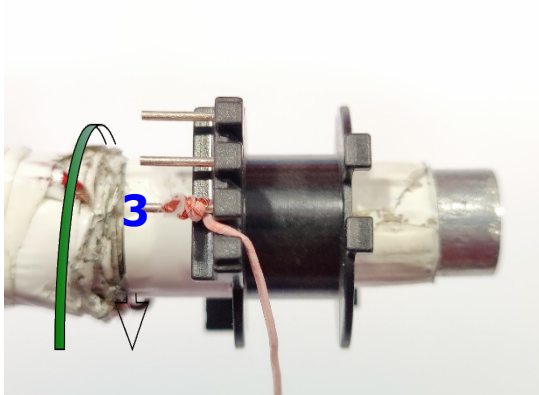
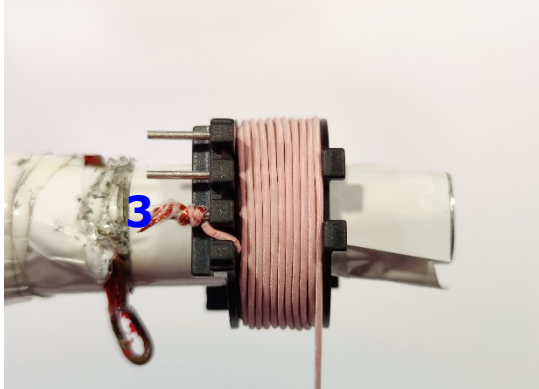

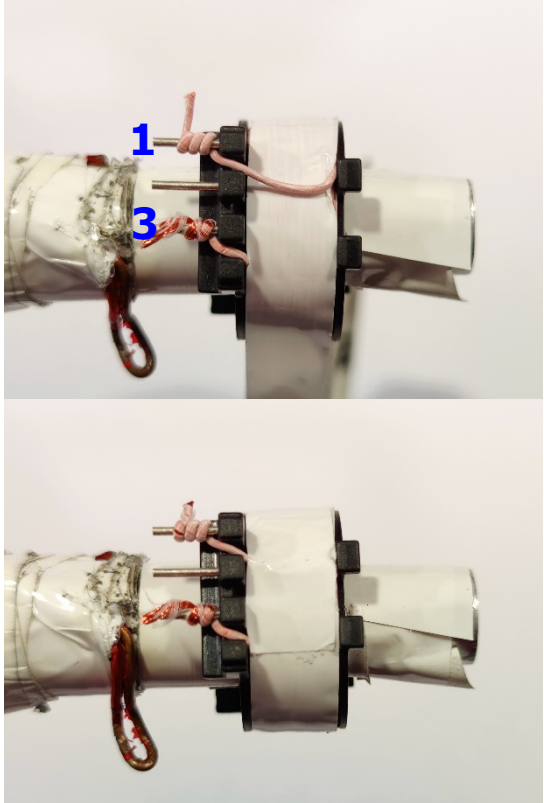
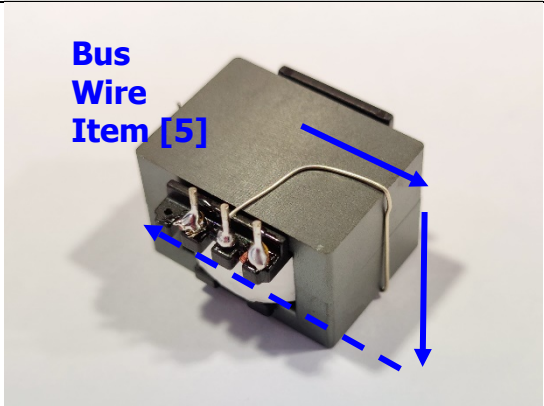

Figure 12 – Inductor Build Diagram.

8.4 Material List

Item	Description
[1]	Core: EQ25, Material 3C95. Ferroxcube.
[2]	Bobbin: EQ25, 4 pin (4/0); PI P/N: 25-01141-00.
[3]	Wire: Served Litz 25/#38.
[4]	Tape: 3M 1350F-1, Polyester Film, 1 mil Thickness, 8.1 mm Width.
[5]	Bus Wire: #30 AWG (Solid) Tinned Copper.
[6]	Tape: 3M 1350F-1, Polyester Film, 1 mil Thickness, 18 mm Width.
[7]	Varnish: Dolph BC-359, or equivalent.

8.5 Winding Instructions

	<p>Assign pins 1, 2, and 3.</p> <p>Cut unused pin 4.</p>
	<p>Position the bobbin on the mandrel such that the pin side of the bobbin is on the left side.</p> <p>Rotation of the mandrel is clock-wise as seen from the right side of the setup.</p>
	<p>Start at pin 3, wind 74 turns of litz wire Item [3].</p> <p>Wind as illustrated in Figure 3, going from left to right in the first layer, then right to left the next layer, and continue until 74 turns is completed within 7 layers.</p>

	<p>At the end of last turn, place tape Item [4] to secure the winding, then bring back wire to finish at pin 1.</p> <p>2 layers of tape Item [4].</p>
 <p>Bus Wire Item [5]</p>	<p>Solder the wires to their respective bobbin pins (pin 1 and 3).</p> <p>Add gap to the middle leg of core Item [1] to get $660 \mu\text{H} \pm 7\%$ inductance.</p> <p>Solder one end of bus wire Item [5] to pin 2 and wrap the bus wire along both core halves.</p>
	<p>Secure core halves by wrapping 2 layers of tape Item [6] along the transformer bottom, sides, and top.</p> <p>Ensure inductance is still $660 \mu\text{H} \pm 7\%$.</p> <p>Varnish with Item [7] to complete the inductor.</p>

9 Transformer Specification (T1)

9.1 Electrical Diagram

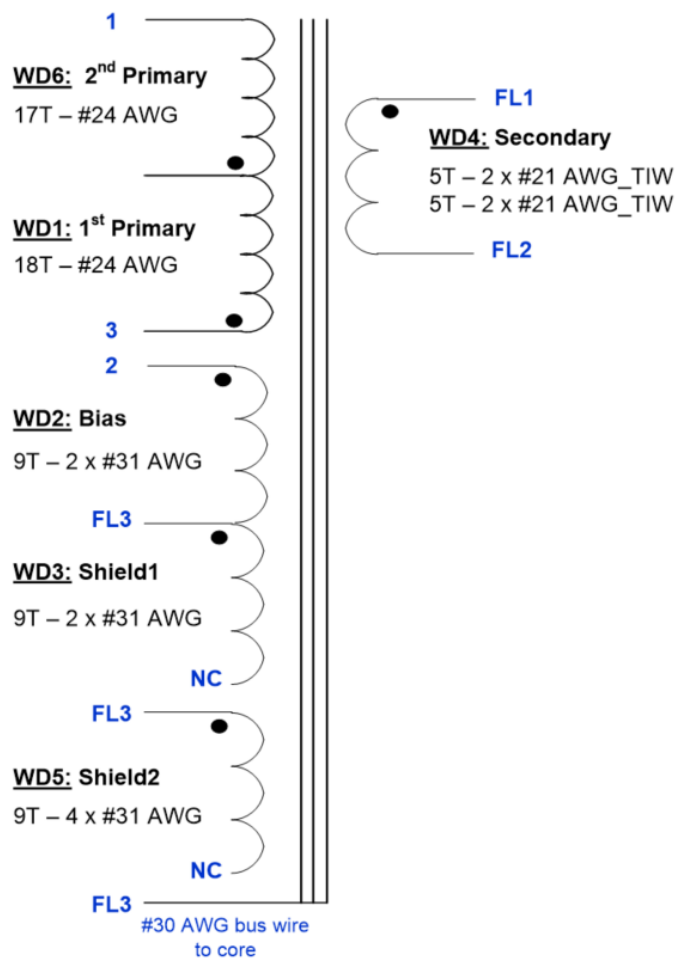

Figure 13 – Transformer Electrical Diagram.

9.2 Electrical Specifications

Parameter	Condition	Spec.
Nominal Primary Inductance	Across pin 1 to pin 3, with all other windings open. LCR meter L_s measurement, 100 kHz, 1.0 V test level.	560 μ H \pm 7%
Primary Leakage Inductance	Across pin 1 to pin 3, with FL1 and FL2 shorted. LCR meter L_s measurement, 100 kHz, 1.0 V test level.	5.5 μ H (Max.)
Resonant Frequency	Across pin 1 to pin 3, with all other windings open.	1,200 kHz (Min.)
Electrical Strength (Primary to Secondary)	Across shorted primary windings (pins 1, 2, 3, FL3) to shorted secondary winding (FL1, FL2).	3000 VAC, 200 V / s ramp rate, 60 s soak

9.3 Transformer Build Diagram

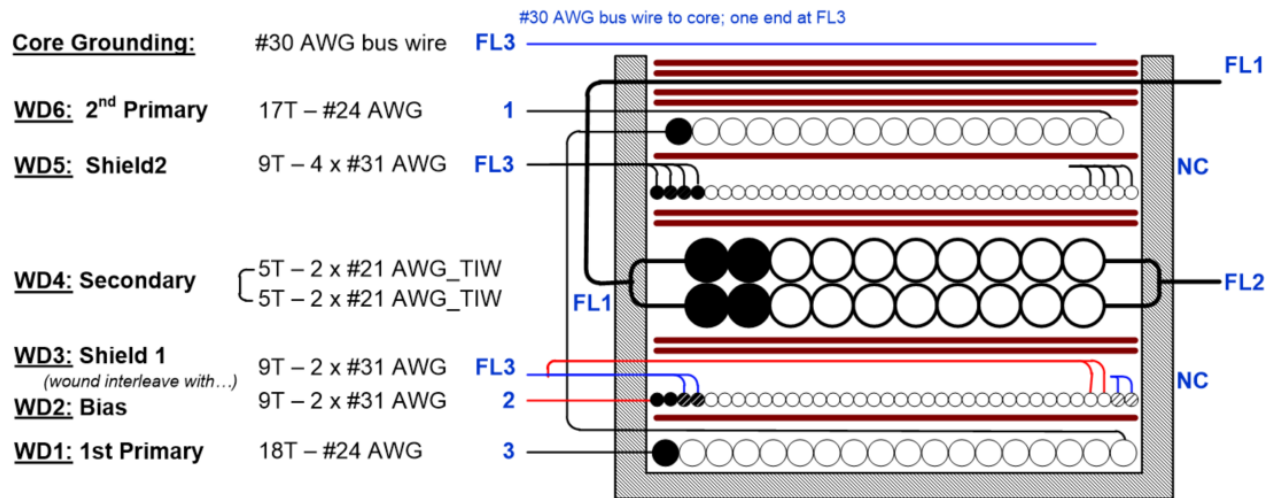
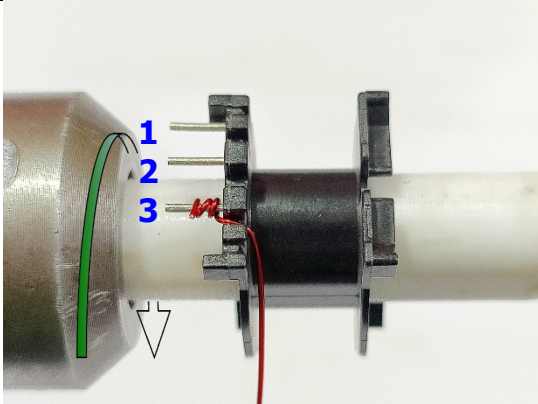
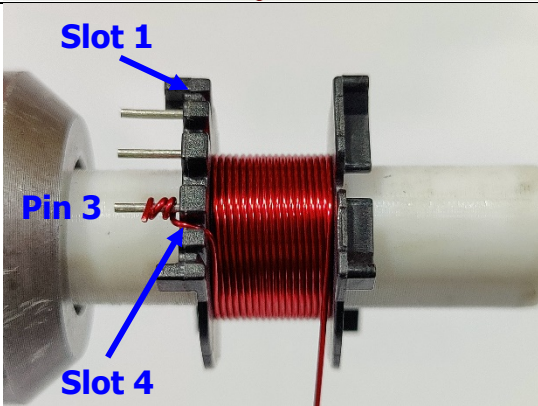
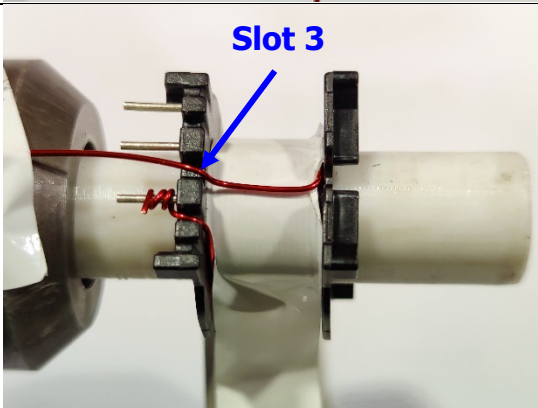
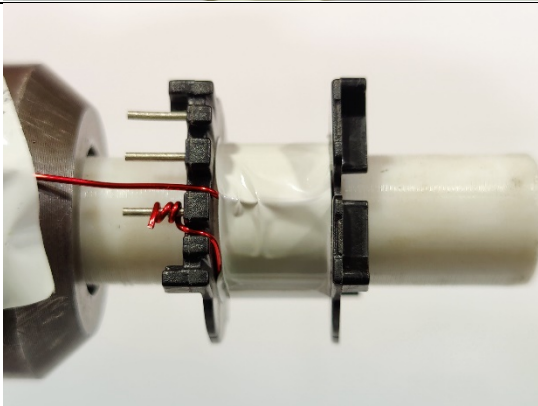

Figure 14 – Transformer Build Diagram.

9.4 Material List

Item	Description
[1]	Core: ATQ27/18.4, Material KP-95. PI#: 99-00079-00.
[2]	Bobbin: ATQ27/18.4 horizontal. TBI-238-03381.12XX. PI#: 25-01178-00.
[3]	Magnet Wire: #24 AWG, Double Coated.
[4]	Magnet Wire: #31 AWG, Double Coated.
[5]	Magnet Wire: #21 AWG, Triple Insulated Wire.
[6]	Bus Wire: #30 AWG (Solid) Tinned Copper.
[7]	Tape: 3M 1350F-1, Polyester Film, 1 mil Thickness, 10.5 mm Width.
[8]	Tape: 3M 1350F-1, Polyester Film, 1 mil Thickness, 20.8 mm Width.
[9]	Varnish: Dolph BC-359.

9.5 *Winding Instructions*

<p>Bobbin and Winding Preparation</p>	 <p>A photograph showing a bobbin on a mandrel. The bobbin has four slots labeled 1, 2, 3, and 4. A red wire is inserted into slot 3. A green arrow on the left indicates the direction of rotation. A white arrow at the bottom points to the right, indicating the direction of rotation.</p>	<p>Position the bobbin on the mandrel such that the pin side of the bobbin is on the left side.</p> <p>Rotation of the mandrel is clock-wise as seen from the right side of the set-up.</p>
<p>WD1 1st Primary</p>	 <p>A photograph showing the bobbin with 18 turns of red wire wound on it. The wire starts at Pin 3 and ends at Slot 4. Labels 'Slot 1', 'Pin 3', and 'Slot 4' are shown with blue arrows pointing to their respective locations.</p>	<p>Start at pin 3, enter wire to bobbin slot 4, and wind 18 turns of wire Item [3] in 1 layer, from left to right.</p>
<p>Insulation</p>	 <p>A photograph showing the bobbin with a piece of white tape (Item [7]) wrapped around it to secure the winding. The wire is brought back to Slot 3. A label 'Slot 3' is shown with a blue arrow pointing to the slot.</p>	<p>At the end of last turn, place tape Item [7] to secure the winding, then bring back wire to the left side bobbin Slot 3.</p> <p>Leave enough wire for the 2nd half Primary (17 turns) to be wound later.</p>
	 <p>A photograph showing the bobbin with a single layer of white tape (Item [7]) wrapped around it.</p>	<p>1 layer of tape Item [7].</p>

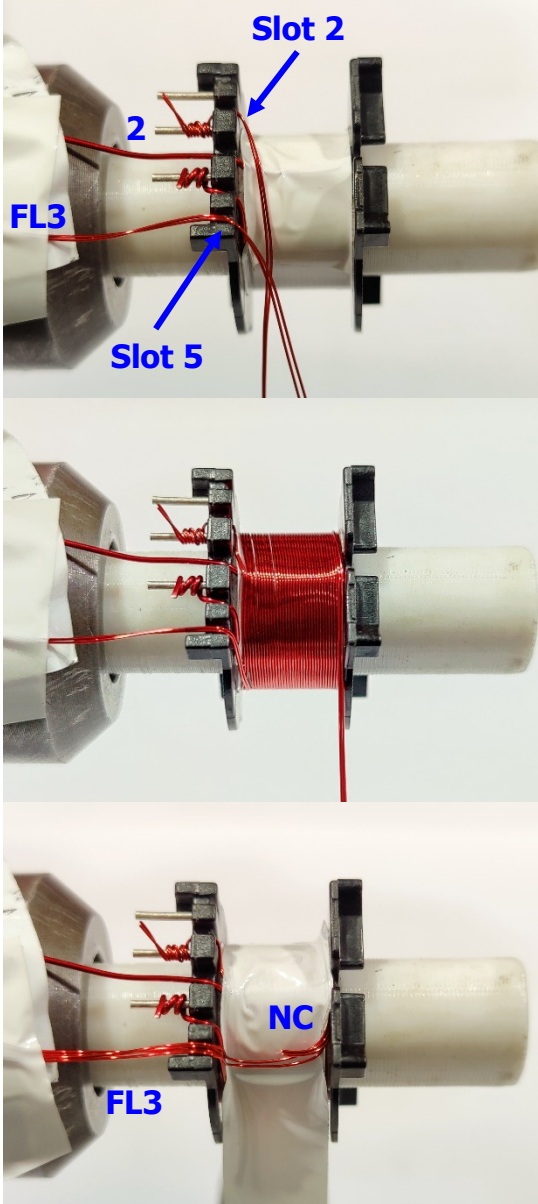
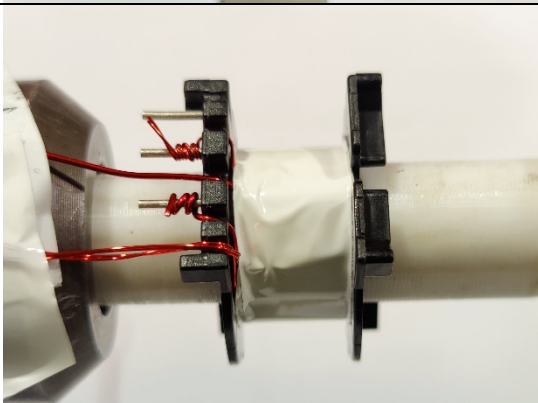
<p>WD2: Bias & WD3: Shield 1</p>		<p>Use 2 wires Item [4] for WD2 (Bias). Start at pin 2 and enter to bobbin slot 2.</p> <p>Use another 2 wires Item [4] for WD3 (Shield). Start as FL3, leave ~2" floating, and enter to bobbin slot 5.</p> <p>Wind all 4 wires 9 turns in parallel.</p> <p>At the end of last turn, place tape Item [7] to secure the windings (do not complete yet the tape layer turn), then bring back 2 wire of WD2 (Bias) to the left to bobbin slot 5 together with FL3.</p> <p>Cut short 2 wires for WD3 (Shield) to approximately 1/3 of bobbin width and leave as No-Connect.</p>
<p>Insulation</p>		<p>2 layers of tape Item [7].</p>

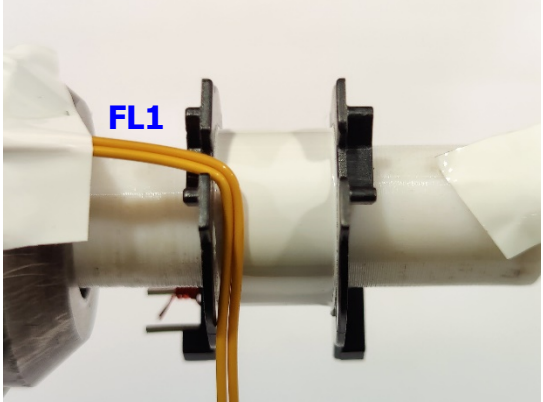
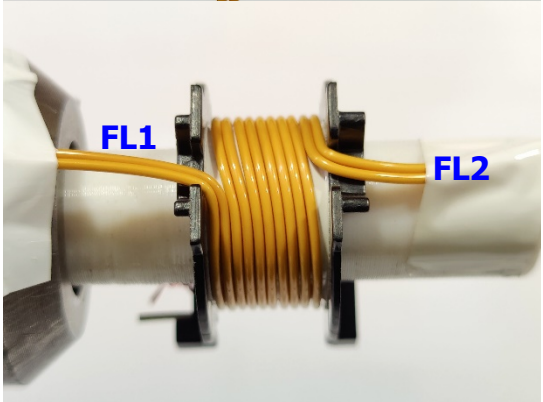
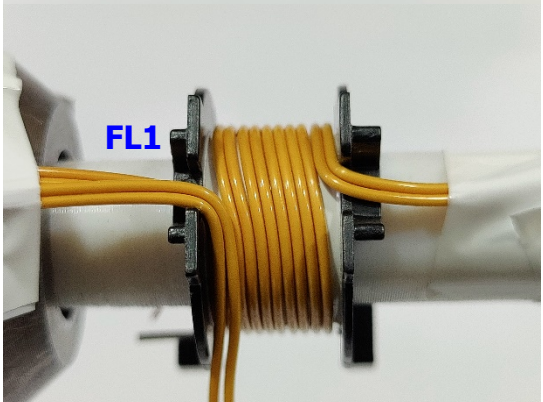
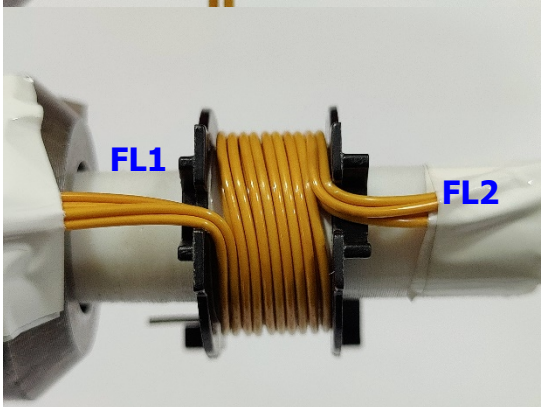
<p style="text-align: center;">WD4 Secondary</p>		<p>Start at the secondary left slot of the bobbin. Use 2 wires Item [5], leave ~2" floating, and mark as FL1.</p>
		<p>Wind 5 turns in 1 layer. At the end of last turn, exit the wires at the right slot, leave ~2" floating and mark as FL2 for 1st half of Secondary.</p>
		<p>Repeat another winding same as above for 2nd half of Secondary, which is parallel with 1st half Secondary.</p>
		

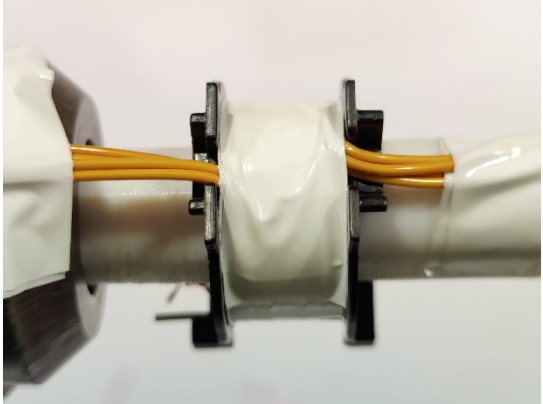
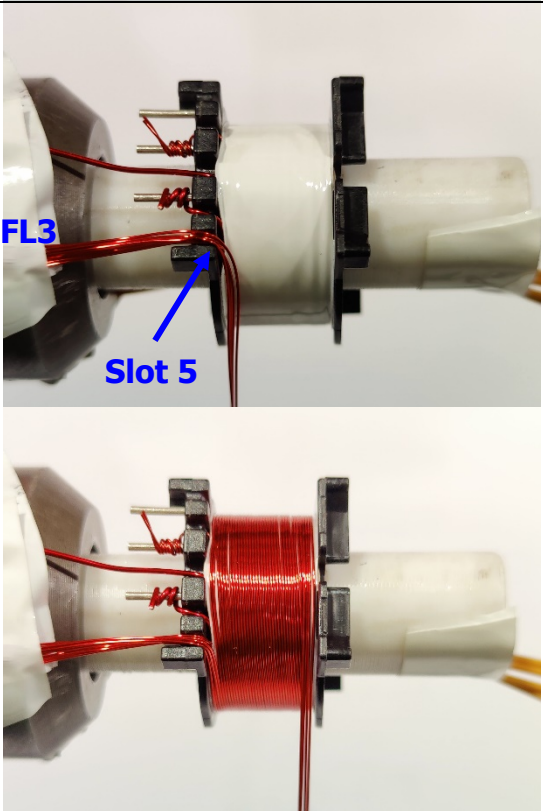
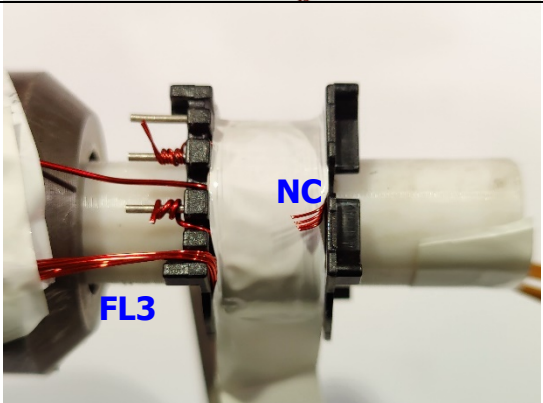
<p>Insulation</p>		<p>2 layers of tape Item [7].</p>
<p>WD5 Shield2</p>		<p>Use 4 wires Item [4] for WD5 (Shield 2).</p> <p>Start with FL3, enter to bobbin slot 5, and wind 9 turns in parallel.</p>
		<p>At the end of last turn, place tape Item [7] to secure the winding (do not complete yet the tape layer turn).</p> <p>Then cut short the 4 wires to approximately 1/3 of bobbin width and leave as No-Connect.</p>

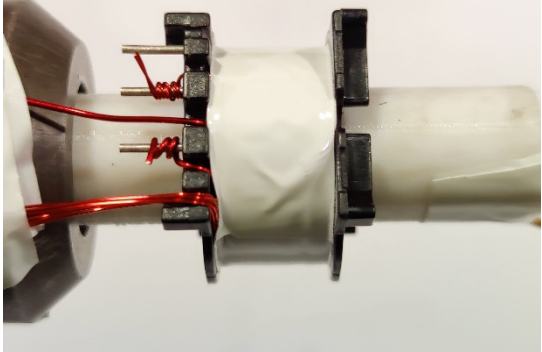
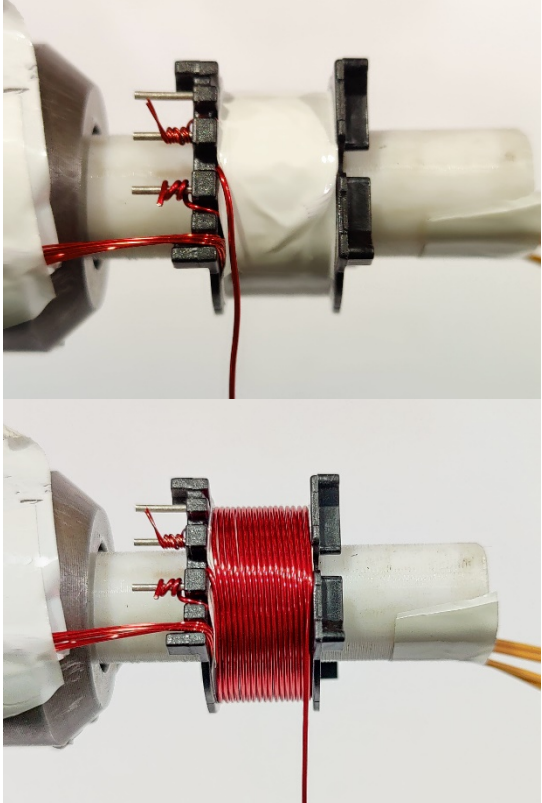
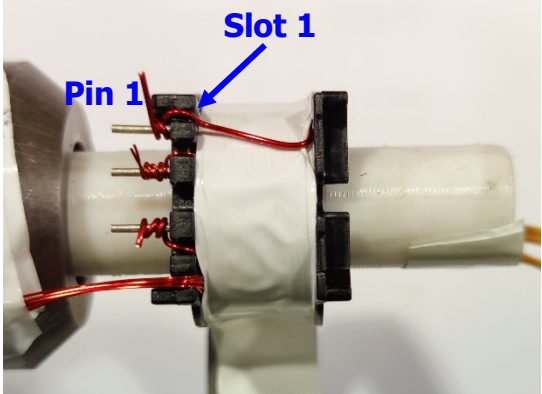
<p>Insulation</p>		<p>1 layer of tape Item [7].</p>
<p>WD6 2nd Primary</p>		<p>Use wire hanging from WD1 (Primary) and continue winding 17 turns from left to right.</p>
		<p>At the end of last turn, place tape Item [7] to secure the winding (do not complete yet the tape layer turn), then finish winding at pin 1 through slot 1.</p>

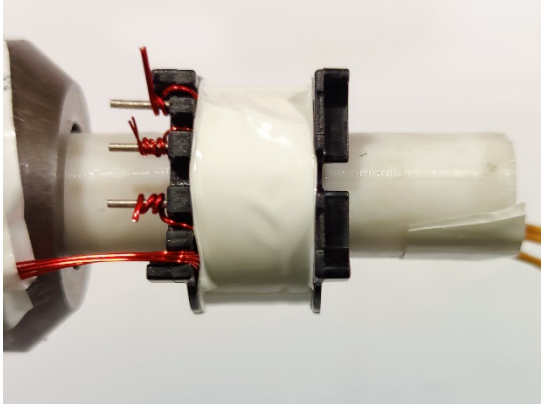
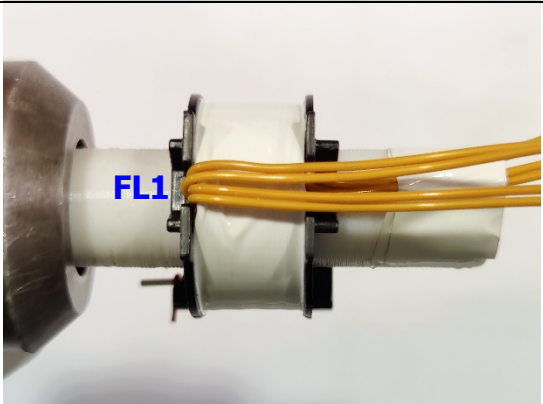
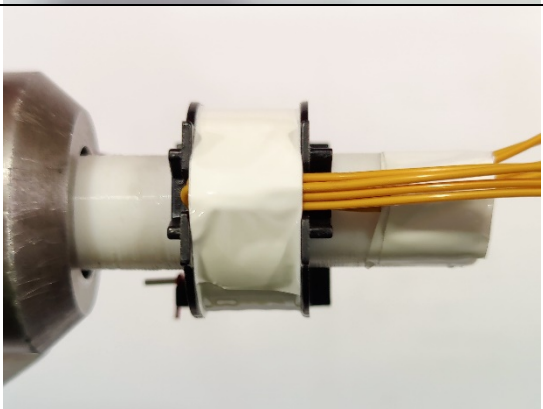
<p>Insulation</p>		<p>2 layers of tape Item [7].</p>
<p>WD4 Secondary</p>		<p>Bring all 4 wires of Secondary Winding FL1 from left slot to exit to the right slot.</p>
<p>Insulation</p>		<p>2 layers of tape Item [7].</p>

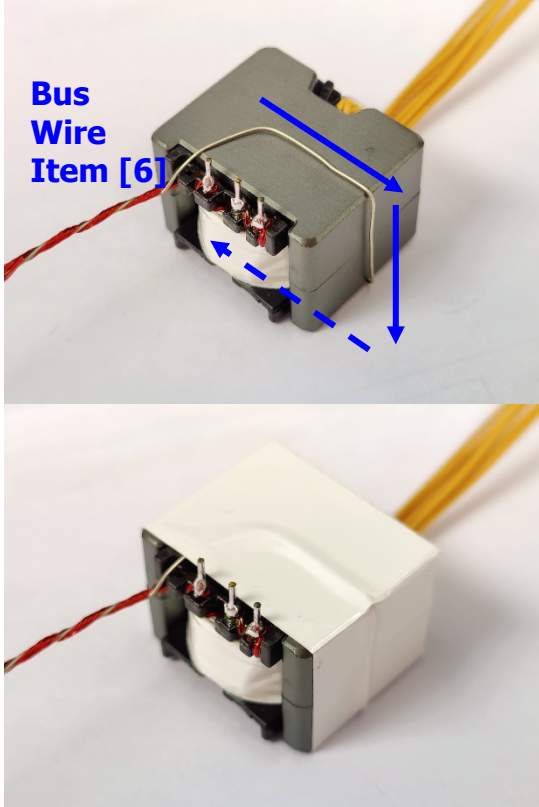
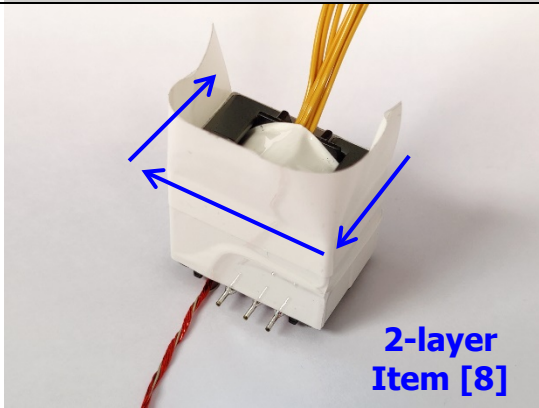
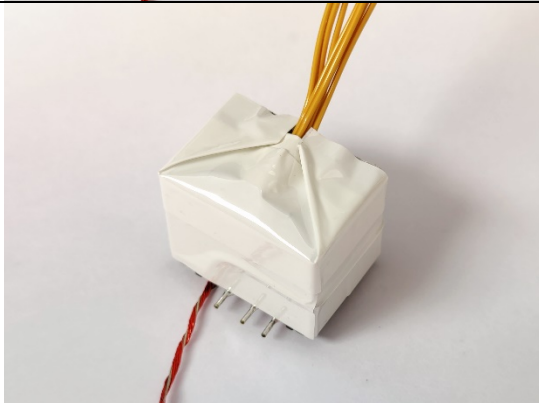
<p>Gap and Ground Core</p>		<p>Solder the wires to their respective bobbin pins (pin 1, 2, 3).</p> <p>Add gap to the middle leg of core Item [1] to get 560 μH \pm7% primary inductance.</p> <p>Twist one end of bus wire Item [6] together with FL3 and wrap the bus wire along both core halves.</p> <p>Secure core halves by wrapping 2 layers of tape Item [8] along the transformer bottom, sides, and top.</p> <p>Ensure primary inductance is still 560 μH \pm7%.</p>
<p>Tape for Core Insulation</p>		<p>Cover the transformer core bottom and secondary side with 2 layers of tape Item [8] for improved ESD performance.</p> <p>Align the tape such it covers about 1/3 of the core bottom surface.</p>
		<p>Fold the excess tape to cover secondary side.</p>

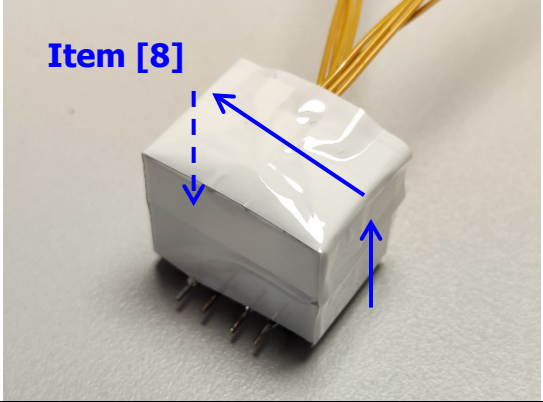
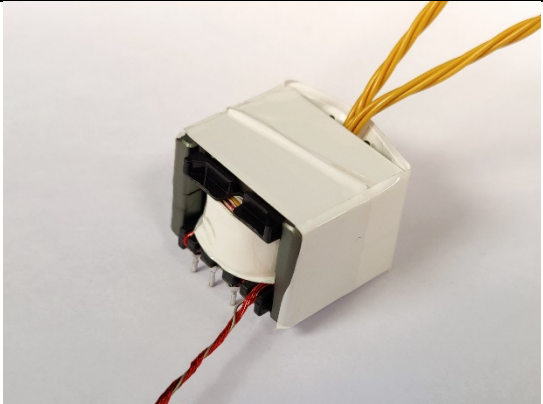
	 <p>Item [8]</p>	<p>Secure the assembly with 1 layer of tape Item [8] along the transformer sides.</p>
<p>Finish Assembly</p>		<p>Twist together the 4 wires of FL1.</p> <p>Also twist together the 4 wires of FL2.</p> <p>Varnish with Item [9] to complete the transformer.</p> <p>Cut excess fly lead wire after soldering the transformer into the PCB.</p>

10 PFC Inductor Design Spreadsheet

1	Hiper_PFS-4_Boost_051921; Rev.1.3; Copyright Power Integrations 2021	INPUT	INFO	OUTPUT	UNITS	Continuous Mode Boost Converter Design Spreadsheet
2	Enter Application Variables					
3	Input Voltage Range	Universal		Universal		Input voltage range
4	VACMIN	90		90	VAC	Minimum AC input voltage. Spreadsheet simulation is performed at this voltage. To examine operation at other voltages, enter here, but enter fixed value for LPFC_ACTUAL.
5	VACMAX	265		265	VAC	Maximum AC input voltage
6	VBROWNIN		Info	78	VAC	Brown-IN voltage has been modified since the V-pin ratio is no longer 100:1
7	VBROWNOUT		Info	68	VAC	Brown-OUT voltage has been modified since the V-pin ratio is no longer 100:1
8	VO	380	Info	380	VDC	Brown IN/OUT voltage has changed due to modifications in the V-pin ratio from 100:1. Recommend Vpin ratio= FB pin ratio for optimized operation. Check the PF, input current distortion, brown in/out and power delivery
9	PO	105		105	W	Nominal Output power
10	fL			50	Hz	Line frequency
11	TA Max	40		40	°C	Maximum ambient temperature
12	Efficiency Estimate	0.95		0.95		Enter the efficiency estimate for the boost converter at VACMIN. Should approximately match calculated efficiency in Loss Budget section
13	VO_MIN			361	VDC	Minimum Output voltage
14	VO_RIPPLE_MAX			20	VDC	Maximum Output voltage ripple
15	T_HOLDUP			20	ms	Holdup time
16	VHOLDUP_MIN	280		280	VDC	Minimum Voltage Output can drop to during holdup
17	I_INRUSH			40	A	Maximum allowable inrush current
18	Forced Air Cooling	No		No		Enter "Yes" for Forced air cooling. Otherwise enter "No". Forced air reduces acceptable choke current density and auto pick core size
20	KP and INDUCTANCE					
21	KP_TARGET	0.94	Warning	0.94		Device current capability exceeded. Reduce KP_Target or PO
22	LPFC_TARGET (0 bias)			661	uH	PFC inductance required to hit KP_TARGET at peak of VACMIN and full load
23	LPFC_DESIRED (0 bias)	661		661	uH	LPFC value used for calculations. Leave blank to use LPFC_TARGET. Enter value to hold constant (also enter core selection) while changing VACMIN to examine brownout operation. Calculated inductance with rounded (integral) turns for powder core.
24	KP_ACTUAL			0.978		Actual KP calculated from LPFC_DESIRED
25	LPFC_PEAK			661	uH	Inductance at VACMIN and maximum bias current. For Ferrite, same as LPFC_DESIRED (0 bias)
27	Basic current parameters					
28	IAC_RMS			1.23	A	AC input RMS current at VACMIN and Full Power load
29	IO_DC			0.28	A	Output average current/Average diode current
32	PFS Parameters					
33	PFS Package	C		C		HiperPFS package selection
34	PFS Part Number	PFS7628C		PFS7628C		If examining brownout operation, over-ride auto pick with desired device size



35	Operating Mode	Full Power		Full Power		Mode of operation of PFS. For Full Power mode enter "Full Power" otherwise enter "EFFICIENCY" to indicate efficiency mode
36	IOCP min			3.15	A	Minimum Current limit
37	IOCP typ			3.33	A	Typical current limit
38	IOCP max			3.47	A	Maximum current limit
39	IP		Warning	3.15	A	MOSFET IOCP is reached. Input AC waveform will undergo clipping, reducing PF. Reduce KP or select larger PFS
40	IRMS			1.25	A	PFS MOSFET RMS current
41	RDSON			0.39	Ohms	Typical RDSon at 100 °C
42	FS_PK			41.4	kHz	Estimated frequency of operation at crest of input voltage (at VACMIN)
43	FS_AVG			36.0	kHz	Estimated average frequency of operation over line cycle (at VACMIN)
44	PCOND_LOSS_PFS			0.607	W	Estimated PFS Switch conduction losses
45	PSW_LOSS_PFS			0.631	W	Estimated PFS Switch switching losses
46	PFS_TOTAL			1.238	W	Total Estimated PFS Switch losses
47	TJ Max			100	deg C	Maximum steady-state junction temperature
48	Rth-JS			2.80	°C/W	Maximum thermal resistance (Junction to heatsink)
49	HEATSINK Theta-CA			45.68	°C/W	Maximum thermal resistance of heatsink
52	INDUCTOR DESIGN					
53	Basic Inductor Parameters					
54	LPFC (0 Bias)			661	uH	Value of PFC inductor at zero current. This is the value measured with LCR meter. For powder, it will be different than LPFC.
55	LP_TOL	7.0		7.0	%	Tolerance of PFC Inductor Value (ferrite only)
56	IL_RMS			1.46	A	Inductor RMS current (calculated at VACMIN and Full Power Load)
57	Material and Dimensions					
58	Core Type	Ferrite		Ferrite		Enter "Sendust", "Iron Powder" or "Ferrite"
59	Core Material	PC44/PC95		PC44/PC95		Select from 60u, 75u, 90u or 125 u for Sendust cores. Fixed at PC44/PC95 for Ferrite cores. Fixed at -52 material for Pow Iron cores.
60	Core Geometry	EQ		EQ		Toroid only for Sendust and Powdered Iron; EE or PQ for Ferrite cores.
61	Core	EQ25		EQ25		Core part number
62	Ae			100.00	mm ²	Core cross sectional area
63	Le			41.40	mm	Core mean path length
64	AL			4400.00	nH/t ²	Core AL value
65	Ve			4.15	cm ³	Core volume
66	HT (EE/PQ/EQ/RM/POT) / ID (toroid)			4.95	mm	Core height/Height of window; ID if toroid
67	MLT			57.0	mm	Mean length per turn
68	BW	8.10		8.10	mm	Bobbin width
69	LG			0.91	mm	Gap length (Ferrite cores only)
70	Flux and MMF calculations					
71	BP_TARGET (ferrite only)	3317		3317	Gauss	Target flux density at worst case: IOCP and maximum tolerance inductance (ferrite only) - drives turns and gap
72	B_OCP (or BP)			3317	Gauss	Target flux density at worst case: IOCP and maximum tolerance inductance (ferrite only) - drives turns and gap
73	B_MAX			2814	Gauss	Peak flux density at AC peak, VACMIN and Full Power Load, nominal inductance, minimum IOCP
74	μ_TARGET (powder only)			N/A	%	target μ at peak current divided by μ at zero current, at VACMIN, full load (powder only) - drives auto core selection
75	μ_MAX (powder only)			N/A	%	actual μ at peak current divided by μ at zero current, at VACMIN, full load (powder only)

76	μ _OCP (powder only)			N/A	%	μ at IOC Ptyp divided by μ at zero current
77	I_TEST			3.3	A	Current at which B_TEST and H_TEST are calculated, for checking flux at a current other than IOCP or IP; if blank IOCP_typ is used.
78	B_TEST			3183	Gauss	Flux density at I_TEST and maximum tolerance inductance
79	μ _TEST (powder only)			N/A	%	μ at IOCP divided by μ at zero current, at IOCPtyp
80	Wire					
81	TURNS			74		Inductor turns. To adjust turns, change BP_TARGET (ferrite) or μ _TARGET (powder)
82	ILRMS			1.46	A	Inductor RMS current
83	Wire type	Litz		Litz		Select between "Litz" or "Magnet" for double coated magnet wire
84	AWG	38		38	AWG	Inductor wire gauge
85	Filar	25		25		Inductor wire number of parallel strands. Leave blank to auto-calc for Litz
86	OD (per strand)			0.102	mm	Outer diameter of single strand of wire
87	OD bundle (Litz only)			0.71	mm	Will be different than OD if Litz
88	DCR			0.464	ohm	Choke DC Resistance
89	P AC Resistance Ratio			1.13		Ratio of total copper loss, including HF AC, to the DC component of the loss
90	J		Warning	7.22	A/mm ²	Current density is high, if copper loss is high use thicker wire, more strands, or larger core
91	FIT			93	%	Percentage fill of winding window for EE/PQ core. Full window approx. 90%
92	Layers			6.85		Estimated layers in winding
93	Loss calculations					
94	BAC-p-p			2752	Gauss	Core AC peak-peak flux excursion at VACMIN, peak of sine wave
95	LPFC_CORE_LOSS			0.075	W	Estimated Inductor core Loss
96	LPFC_COPPER_LOSS			1.128	W	Estimated Inductor copper losses
97	LPFC_TOTAL_LOSS			1.203	W	Total estimated Inductor Losses
100	PFC Diode					
101	PFC Diode Part Number	STTH3R06		STTH3R06		PFS Diode Part Number
102	Type / Part Number			ULTRAFast		PFC Diode Type / Part Number
103	Manufacturer			ST		Diode Manufacturer
104	VRRM			600.0	V	Diode rated reverse voltage
105	IF			3.00	A	Diode rated forward current
106	Qrr		Info	190.0	nC	Qrr too high: Will result in high diode loss
107	VF			1.25	V	Diode rated forward voltage drop
108	PCOND_DIODE			0.368	W	Estimated Diode conduction losses
109	PSW_DIODE			0.111	W	Estimated Diode switching losses
110	P_DIODE			0.479	W	Total estimated Diode losses
111	TJ Max			100.0	deg C	Maximum steady-state operating temperature
112	Rth-JS		Info	20.00	degC/W	Rth too high. Will result in high diode loss
113	HEATSINK Theta-CA			104.89	degC/W	Maximum thermal resistance of heatsink
114	IFSM			55.0	A	Non-repetitive peak surge current rating. Consider larger size diode if inrush or thermal limited.
117	Output Capacitor					
118	COUT	100		100	μ F	Minimum value of Output capacitance
119	VO_RIPPLE_EXPECTED			9.3	V	Expected ripple voltage on Output with selected Output capacitor
120	T_HOLDUP_EXPECTED			31.4	ms	Expected holdup time with selected Output capacitor
121	ESR_LF			2.93	ohms	Low Frequency Capacitor ESR
122	ESR_HF		Warning	1.17	ohms	High frequency ESR must be between 0.01 and 1 ohms
123	IC_RMS_LF			0.19	A	Low Frequency Capacitor RMS current
124	IC_RMS_HF			0.67	A	High Frequency Capacitor RMS current

125	CO_LF_LOSS			0.106	W	Estimated Low Frequency ESR loss in Output capacitor
126	CO_HF_LOSS			0.525	W	Estimated High frequency ESR loss in Output capacitor
127	Total CO LOSS			0.632	W	Total estimated losses in Output Capacitor
130	Input Bridge (BR1) and Fuse (F1)					
131	I ² t Rating			7.02	A ² *s	Minimum I ² t rating for fuse
132	Fuse Current rating			1.98	A	Minimum Current rating of fuse
133	VF			0.90	V	Input bridge Diode forward Diode drop
134	IAVG			1.23	A	Input average current at VBROWNOUT.
135	PIV_INPUT BRIDGE			375	V	Peak inverse voltage of input bridge
136	PCOND_LOSS_BRIDGE			1.990	W	Estimated Bridge Diode conduction loss
137	CIN			0.33	uF	Input capacitor. Use metallized polypropylene or film foil type with high ripple current rating
138	CIN_DF			0.001		Input Capacitor Dissipation Factor (tan Delta)
139	CIN_PLOSS			0.009	W	Input Capacitor Loss
140	RT1			9.37	ohms	Input Thermistor value
141	D_Precharge			1N5407		Recommended precharge Diode
144	PFS4 small signal components					
145	C_REF			1.0	uF	REF pin capacitor value
146	RV1			4.0	MOhms	Line sense resistor 1
147	RV2			6.0	MOhms	Line sense resistor 2
148	RV3			6.0	MOhms	Typical value of the lower resistor connected to the V-PIN. Use 1% resistor only!
149	RV4			163.8	kOhms	Description pending, could be modified based on feedback chain R1-R4
150	C_V			0.489	nF	V pin decoupling capacitor (RV4 and C_V should have a time constant of 80us) Pick the closest available capacitance.
151	C_VCC			1.0	uF	Supply decoupling capacitor
152	C_C			100	nF	Feedback C pin decoupling capacitor
153	Power good Vo lower threshold VPG(L)			333	V	Vo lower threshold voltage at which power good signal will trigger
154	PGT set resistor			337.4	kohm	Power good threshold setting resistor
157	Feedback Components					
158	RFB_1			4.00	Mohms	Feedback network, first high voltage divider resistor
159	RFB_2			6.00	Mohms	Feedback network, second high voltage divider resistor
160	RFB_3			6.00	Mohms	Feedback network, third high voltage divider resistor
161	RFB_4			163.8	kohms	Feedback network, lower divider resistor
162	CFB_1			0.489	nF	Feedback network, loop speedup capacitor. (R4 and C1 should have a time constant of 80us) Pick the closest available capacitance.
163	RFB_5			35.7	kohms	Feedback network: zero setting resistor
164	CFB_2			1000	nF	Feedback component- noise suppression capacitor
167	Loss Budget (Estimated at VACMIN)					
168	PFS Losses			1.238	W	Total estimated losses in PFS
169	Boost diode Losses			0.479	W	Total estimated losses in Output Diode
170	Input Bridge losses			1.990	W	Total estimated losses in input bridge module
171	Input Capacitor Losses			0.009	W	Total estimated losses in input capacitor
172	Inductor losses			1.203	W	Total estimated losses in PFC choke
173	Output Capacitor Loss			0.632	W	Total estimated losses in Output capacitor
174	EMI choke copper loss			0.151	W	Total estimated losses in EMI choke copper
175	Total losses			5.701	W	Overall loss estimate
176	Efficiency			0.95		Estimated efficiency at VACMIN, full load.
179	CAPZero component selection recommendation					
180	CAPZero Device			CAP200DG		(Optional) Recommended CAPZero device to discharge X-Capacitor with time constant of 1 second

181	Total Series Resistance (Rcapzero1+Rcapzero2)			0.730	MOhms	Maximum Total Series resistor value to discharge X-Capacitors
184	EMI filter components recommendation					
185	CX2			470	nF	X capacitor after differential mode choke and before bridge, ratio with Po
186	LDM_calc			317	uH	Estimated minimum differential inductance to avoid <10kHz resonance in input current
187	CX1			470	nF	X capacitor before common mode choke, ratio with Po
188	LCM			10.0	mH	typical common mode choke value
189	LCM_leakage			30	uH	estimated leakage inductance of CM choke, typical from 30~60uH
190	CY1 (and CY2)			220	pF	typical Y capacitance for common mode noise suppression
191	LDM_Actual			287	uH	cal_LDM minus LCM_leakage, utilizing CM leakage inductance as DM choke.
192	DCR_LCM			0.070	Ohms	Total DCR of CM choke for estimating copper loss
193	DCR_LDM			0.030	Ohms	Total DCR of DM choke(or CM #2) for estimating copper loss
195	Note: CX2 can be placed between CM chock and DM choke depending on EMI design requirement.					

Note: The warnings on the spreadsheet have been verified to not be an issue for this design. For lines 21 (KP_TARGET) and 39 (IP), the target power factor is still achieved with PFS switch current clipped to IOCP at minimum VIN. For line 90 (J), high system efficiency is still achieved.

11 Transformer Design Spreadsheet

Two transformer design spreadsheets are presented in this section

- Flyback stage with PFC ON (100 W output operation)
- Flyback stage with PFC OFF (65 W output operation)

11.1 Flyback Stage with PFC ON

1	ACDC_InnoSwitch3-PD_Flyback_032521; Rev.0.4; Copyright Power Integrations 2021	INPUT	INFO	OUTPUT	UNITS	InnoSwitch3-PD Flyback Design Spreadsheet
2	APPLICATION VARIABLES					
3	VAC_MIN	269		269	V	Minimum AC line voltage
4	VAC_MAX	269		269	V	Maximum AC input voltage
5	VAC_RANGE			HIGH LINE		AC line voltage range
6	FLINE			60	Hz	AC line voltage frequency
7	CAP_INPUT	100.0		100.0	uF	Input capacitance
9	SET-POINT 1					
10	VOUT1	21.00		21.00	V	Output voltage 1, should be the highest output voltage required
11	IOUT1	4.750		4.750	A	Output current 1
12	POUT1		Info	99.75	W	The output power required exceeds the device capability: Verify thermal performance if no other warnings
13	EFFICIENCY1	0.96		0.96		Converter efficiency for output 1
14	Z_FACTOR1	0.50		0.50		Z-factor for output 1
15	TYPE	APDO		APDO		Select whether this set-point is a PDO(Power Delivery Object) or APDO (Additional Power Delivery Object)
17	SET-POINT 2					
18	VOUT2	20.00		20.00	V	Output voltage 2
19	IOUT2	5.000		5.000	A	Output current 2
20	POUT2		Info	100.00	W	The output power required exceeds the device capability: Verify thermal performance if no other warnings
21	EFFICIENCY2	0.96		0.96		Converter efficiency for output 2
22	Z_FACTOR2	0.50		0.50		Z-factor for output 2
23	TYPE	PDO		PDO		Select whether this set-point is a PDO(Power Delivery Object) or APDO (Additional Power Delivery Object)
25	SET-POINT 3					
26	VOUT3	15.00		15.00	V	Output voltage 3
27	IOUT3	5.000		5.000	A	Output current 3
28	POUT3			75.00	W	Output power 3
29	EFFICIENCY3	0.95		0.95		Converter efficiency for output 3
30	Z_FACTOR3	0.50		0.50		Z-factor for output 3
31	TYPE	PDO		PDO		Select whether this set-point is a PDO(Power Delivery Object) or APDO (Additional Power Delivery Object)
33	SET-POINT 4					
34	VOUT4	12.00		12.00	V	Output voltage 4
35	IOUT4	5.000		5.000	A	Output current 4
36	POUT4			60.00	W	Output power 4
37	EFFICIENCY4	0.94		0.94		Converter efficiency for output 4
38	Z_FACTOR4	0.50		0.50		Z-factor for output 4
39	TYPE	PDO	Info	PDO		The voltage entered is not a standard PDO(Power Delivery Object)
41	SET-POINT 5					
42	VOUT5	9.00		9.00	V	Output voltage 5
43	IOUT5	5.000		5.000	A	Output current 5
44	POUT5			45.00	W	Output power 5



45	EFFICIENCY5	0.93		0.93		Converter efficiency for output 5
46	Z_FACTOR5	0.50		0.50		Z-factor for output 5
47	TYPE	PDO		PDO		Select whether this set-point is a PDO(Power Delivery Object) or APDO (Additional Power Delivery Object)
49	SET-POINT 6					
50	VOUT6	5.00		5.00	V	Output voltage 6
51	IOUT6	5.000		5.000	A	Output current 6
52	POUT6			25.00	W	Output power 6
53	EFFICIENCY6	0.92		0.92		Converter efficiency for output 6
54	Z_FACTOR6	0.50		0.50		Z-factor for output 6
55	TYPE	PDO		PDO		Select whether this set-point is a PDO(Power Delivery Object) or APDO (Additional Power Delivery Object)
57	SET-POINT 7					
58	VOUT7	3.30		3.30	V	Output voltage 7
59	IOUT7	5.000		5.000	A	Output current 7
60	POUT7			16.50	W	Output power 7
61	EFFICIENCY7	0.89		0.89		Converter efficiency for output 7
62	Z_FACTOR7	0.50		0.50		Z-factor for output 7
63	TYPE	APDO		APDO		Select whether this set-point is a PDO(Power Delivery Object) or APDO (Additional Power Delivery Object)
81	VOLTAGE_CDC	0.000		0.000	V	Cable drop compensation desired at maximum output current
85	PRIMARY CONTROLLER SELECTION					
86	ENCLOSURE	ADAPTER		ADAPTER		Power supply enclosure
87	ILIMIT_MODE	INCREASED		INCREASED		Device current limit mode
88	VDRAIN_BREAKDOWN	750		750	V	Device breakdown voltage
89	DEVICE_GENERIC	INN38X0		INN38X0		Device selection
90	DEVICE_CODE			INN3870C		Device code
91	PDEVICE_MAX			90	W	Device maximum power capability
92	RDSON_25DEG			0.39	Ω	Primary switch on-time resistance at 25°C
93	RDSON_100DEG			0.54	Ω	Primary switch on-time resistance at 100°C
94	ILIMIT_MIN			2.395	A	Primary switch minimum current limit
95	ILIMIT_TYP			2.576	A	Primary switch typical current limit
96	ILIMIT_MAX			2.756	A	Primary switch maximum current limit
97	VDRAIN_ON_PRSW			0.15	V	Primary switch on-time voltage drop
98	VDRAIN_OFF_PRSW			595.966	V	Peak drain voltage on the primary switch during turn-off
102	WORST CASE ELECTRICAL PARAMETERS					
103	FSWITCHING_MAX	73289	Info	73289	Hz	The worst case minimum operating frequency is less than 25kHz: may result in audible noise
104	VOR	147.0		147.0	V	Voltage reflected to the primary winding (corresponding to set-point 1) when the primary switch turns off
105	VMIN	380.00	Info	380.00	V	A manual overwrite of VMIN voids the value of input capacitor calculated by the tool or manually entered by the user and will be used for all calculations
106	KP			1.026		Measure of continuous/discontinuous mode of operation
107	MODE_OPERATION			DCM		Mode of operation
108	DUTYCYCLE			0.236		Primary switch duty cycle
109	TIME_ON			3.99	us	Primary switch on-time
110	TIME_OFF			10.47	us	Primary switch off-time
111	LPRIMARY_MIN			521.0	uH	Minimum primary magnetizing inductance
112	LPRIMARY_TYP			560.2	uH	Typical primary magnetizing inductance
113	LPRIMARY_TOL	7.0		7.0	%	Primary magnetizing inductance tolerance
114	LPRIMARY_MAX			599.5	uH	Maximum primary magnetizing inductance
116	PRIMARY CURRENT					
117	IAVG_PRIMARY			0.269	A	Primary switch average current



118	IPEAK_PRIMARY			2.575	A	Primary switch peak current
119	IPEDESTAL_PRIMARY			0.000	A	Primary switch current pedestal
120	IRIPPLE_PRIMARY			2.575	A	Primary switch ripple current
121	IRMS_PRIMARY			0.679	A	Primary switch RMS current
123	SECONDARY CURRENT					
124	IPEAK_SECONDARY			18.022	A	Secondary winding peak current
125	IPEDESTAL_SECONDARY			0.000	A	Secondary winding pedestal current
126	IRMS_SECONDARY			7.830	A	Secondary winding RMS current
127	IRIPPLE_CAP_OUT			6.026	A	Output capacitor ripple current
131	TRANSFORMER CONSTRUCTION PARAMETERS					
132	CORE SELECTION					
133	CORE	ATQ27/18	Info	ATQ27/18		Refer to the Transformer Parameters tab to verify fit factor
134	CORE NAME			ATQ27/18		Core code
135	AE			131.0	mm ²	Core cross sectional area
136	LE			50.8	mm	Core magnetic path length
137	AL			7350	nH/t ²	Ungapped core effective inductance per turns squared
138	VE			6655	mm ³	Core volume
139	BOBBIN NAME			TBI-238-03381.12XX		Bobbin name
140	AW			51.0	mm ²	Bobbin window area
141	BW			10.40	mm	Bobbin width
142	MARGIN			0.0	mm	Bobbin safety margin
144	PRIMARY WINDING					
145	NPRIMARY			35		Primary winding number of turns
146	BPEAK			3688	Gauss	Peak flux density
147	BMAX			3303	Gauss	Maximum flux density
148	BAC			1652	Gauss	AC flux density (0.5 x Peak to Peak)
149	ALG			457	nH/t ²	Typical gapped core effective inductance per turns squared
150	LG			0.338	mm	Core gap length
151	LAYERS_PRIMARY	2		2		Primary winding number of layers
152	AWG_PRIMARY			24		Primary wire gauge
153	OD_PRIMARY_INSULATED			0.577	mm	Primary wire insulated outer diameter
154	OD_PRIMARY_BARE			0.511	mm	Primary wire bare outer diameter
155	CMA_PRIMARY		Info	594.9	Cmils/A	The primary winding wire CMA is higher than 500 mil ² /Amperes: Decrease the primary layers or wire thickness
157	SECONDARY WINDING					
158	NSECONDARY	5		5		Secondary winding number of turns
159	AWG_SECONDARY			18		Secondary wire gauge
160	OD_SECONDARY_INSULATED			1.328	mm	Secondary wire insulated outer diameter
161	OD_SECONDARY_BARE			1.024	mm	Secondary wire bare outer diameter
162	CMA_SECONDARY			207.4	Cmils/A	Secondary winding wire CMA
164	BIAS WINDING					
165	NBIAS			10		Bias winding number of turns
169	PRIMARY COMPONENTS SELECTION					
170	LINE UNDERVOLTAGE					
171	BROWN-IN REQUIRED	76.00		76.00	V	Required line brown-in threshold
172	RLS			4.00	MΩ	Connect two 2 MOhm resistors to the V-pin for the required UV/OV threshold
173	BROWN-IN ACTUAL			75.98	V	Actual brown-in threshold using standard resistors
174	BROWN-OUT ACTUAL			66.93	V	Actual brown-out threshold using standard resistors
176	LINE OVERVOLTAGE					
177	OVERVOLTAGE_LINE		Warning	334.21	V	The device voltage stress will be higher than 650V when overvoltage is triggered
179	BIAS WINDING					
180	VBIAS			9.00	V	Rectified bias voltage at the cable disconnect (5V) set-point
181	VF_BIAS			0.70	V	Bias winding diode forward drop

182	VREVERSE_BIASDIODE			117.28	V	Bias diode reverse voltage (not accounting parasitic voltage ring)
183	CBIAS			22	uF	Bias winding rectification capacitor
184	CBPP			4.70	uF	BPP pin capacitor
188	SECONDARY COMPONENTS SELECTION					
189	RECTIFIER					
190	VDRAIN_OFF_SRFET			75.14	V	Secondary rectifier reverse voltage (not accounting parasitic voltage ring)
191	SRFET	AON6220		AON6220		Secondary rectifier (Logic MOSFET)
192	VBREAKDOWN_SRFET			100	V	Secondary rectifier breakdown voltage
193	RDSON_SRFET			7.4	mΩ	SRFET on time drain resistance at 25degC for VGS=4.4V

Note: The warnings on the spreadsheet have been verified to not be an issue for this design.
For line 177 (OVERVOLTAGE_LINE), the InnoSwitch3-PD INN3870C-H805 is a 750 V device.

11.2 Flyback Stage with PFC OFF

1	ACDC_InnoSwitch3-PD_Flyback_032521; Rev.0.4; Copyright Power Integrations 2021	INPUT	INFO	OUTPUT	UNITS	InnoSwitch3-PD Flyback Design Spreadsheet
2	APPLICATION VARIABLES					
3	VAC_MIN	90		90	V	Minimum AC line voltage
4	VAC_MAX	265		265	V	Maximum AC input voltage
5	VAC_RANGE			UNIVERSAL		AC line voltage range
6	FLINE			60	Hz	AC line voltage frequency
7	CAP_INPUT	100.0		100.0	uF	Input capacitance
9	SET-POINT 1					
10	VOUT1	21.00		21.00	V	Output voltage 1, should be the highest output voltage required
11	IOUT1	3.100		3.100	A	Output current 1
12	POUT1			65.10	W	Output power 1
13	EFFICIENCY1	0.93		0.93		Converter efficiency for output 1
14	Z_FACTOR1	0.50		0.50		Z-factor for output 1
15	TYPE	APDO		APDO		Select whether this set-point is a PDO(Power Delivery Object) or APDO (Additional Power Delivery Object)
17	SET-POINT 2					
18	VOUT2	20.00		20.00	V	Output voltage 2
19	IOUT2	3.250		3.250	A	Output current 2
20	POUT2			65.00	W	Output power 2
21	EFFICIENCY2	0.93		0.93		Converter efficiency for output 2
22	Z_FACTOR2	0.50		0.50		Z-factor for output 2
23	TYPE	PDO		PDO		Select whether this set-point is a PDO(Power Delivery Object) or APDO (Additional Power Delivery Object)
25	SET-POINT 3					
26	VOUT3	15.00		15.00	V	Output voltage 3
27	IOUT3	4.330		4.330	A	Output current 3
28	POUT3			64.95	W	Output power 3
29	EFFICIENCY3	0.93		0.93		Converter efficiency for output 3
30	Z_FACTOR3	0.50		0.50		Z-factor for output 3
31	TYPE	PDO		PDO		Select whether this set-point is a PDO(Power Delivery Object) or APDO (Additional Power Delivery Object)
33	SET-POINT 4					
34	VOUT4	12.00		12.00	V	Output voltage 4
35	IOUT4	5.000		5.000	A	Output current 4
36	POUT4			60.00	W	Output power 4
37	EFFICIENCY4	0.93		0.93		Converter efficiency for output 4
38	Z_FACTOR4	0.50		0.50		Z-factor for output 4
39	TYPE	PDO	Info	PDO		The voltage entered is not a standard PDO(Power Delivery Object)
41	SET-POINT 5					
42	VOUT5	9.00		9.00	V	Output voltage 5
43	IOUT5	5.000		5.000	A	Output current 5
44	POUT5			45.00	W	Output power 5
45	EFFICIENCY5	0.93		0.93		Converter efficiency for output 5
46	Z_FACTOR5	0.50		0.50		Z-factor for output 5
47	TYPE	PDO		PDO		Select whether this set-point is a PDO(Power Delivery Object) or APDO (Additional Power Delivery Object)
49	SET-POINT 6					
50	VOUT6	5.00		5.00	V	Output voltage 6

51	IOUT6	5.000		5.000	A	Output current 6
52	POUT6			25.00	W	Output power 6
53	EFFICIENCY6	0.92		0.92		Converter efficiency for output 6
54	Z_FACTOR6	0.50		0.50		Z-factor for output 6
55	TYPE	PDO		PDO		Select whether this set-point is a PDO(Power Delivery Object) or APDO (Additional Power Delivery Object)
57	SET-POINT 7					
58	VOUT7	3.30		3.30	V	Output voltage 7
59	IOUT7	5.000		5.000	A	Output current 7
60	POUT7			16.50	W	Output power 7
61	EFFICIENCY7	0.89		0.89		Converter efficiency for output 7
62	Z_FACTOR7	0.50		0.50		Z-factor for output 7
63	TYPE	APDO		APDO		Select whether this set-point is a PDO(Power Delivery Object) or APDO (Additional Power Delivery Object)
81	VOLTAGE_CDC	0.000		0.000	V	Cable drop compensation desired at maximum output current
85	PRIMARY CONTROLLER SELECTION					
86	ENCLOSURE	ADAPTER		ADAPTER		Power supply enclosure
87	ILIMIT_MODE	INCREASED		INCREASED		Device current limit mode
88	VDRAIN_BREAKDOWN	750		750	V	Device breakdown voltage
89	DEVICE_GENERIC	INN38X0		INN38X0		Device selection
90	DEVICE_CODE			INN3870C		Device code
91	PDEVICE_MAX			75	W	Device maximum power capability
92	RDSON_25DEG			0.39	Ω	Primary switch on-time resistance at 25°C
93	RDSON_100DEG			0.54	Ω	Primary switch on-time resistance at 100°C
94	ILIMIT_MIN			2.395	A	Primary switch minimum current limit
95	ILIMIT_TYP			2.576	A	Primary switch typical current limit
96	ILIMIT_MAX			2.756	A	Primary switch maximum current limit
97	VDRAIN_ON_PRSW			0.42	V	Primary switch on-time voltage drop
98	VDRAIN_OFF_PRSW			590.31	V	Peak drain voltage on the primary switch during turn-off
102	WORST CASE ELECTRICAL PARAMETERS					
103	FSWITCHING_MAX	56755	Info	56755	Hz	The worst case minimum operating frequency is less than 25kHz: may result in audible noise
104	VOR	147.0		147.0	V	Voltage reflected to the primary winding (corresponding to set-point 1) when the primary switch turns off
105	VMIN			87.22	V	Valley of the rectified minimum input AC voltage at full load
106	KP			0.677		Measure of continuous/discontinuous mode of operation
107	MODE_OPERATION			CCM		Mode of operation
108	DUTYCYCLE			0.629		Primary switch duty cycle
109	TIME_ON		Info	15.90	us	Primary switch on-time is greater than 12.4us: Increase the controller switching frequency or increase the VOR
110	TIME_OFF			6.84	us	Primary switch off-time

111	LPRIMARY_MIN			520.8	uH	Minimum primary magnetizing inductance
112	LPRIMARY_TYP			560.0	uH	Typical primary magnetizing inductance
113	LPRIMARY_TOL	7.0		7.0	%	Primary magnetizing inductance tolerance
114	LPRIMARY_MAX			599.2	uH	Maximum primary magnetizing inductance
116	PRIMARY CURRENT					
117	I AVG_PRIMARY			0.778	A	Primary switch average current
118	IPEAK_PRIMARY			2.433	A	Primary switch peak current
119	IPEDESTAL_PRIMARY			0.698	A	Primary switch current pedestal
120	IRIPPLE_PRIMARY			2.372	A	Primary switch ripple current
121	IRMS_PRIMARY			1.135	A	Primary switch RMS current
123	SECONDARY CURRENT					
124	IPEAK_SECONDARY			17.034	A	Secondary winding peak current
125	IPEDESTAL_SECONDARY			4.884	A	Secondary winding pedestal current
126	IRMS_SECONDARY			7.732	A	Secondary winding RMS current
127	IRIPPLE_CAP_OUT			5.897	A	Output capacitor ripple current
131	TRANSFORMER CONSTRUCTION PARAMETERS					
132	CORE SELECTION					
133	CORE	ATQ27/18	Info	ATQ27/18		Refer to the Transformer Parameters tab to verify fit factor
134	CORE NAME			ATQ27/18		Core code
135	AE			131.0	mm ²	Core cross sectional area
136	LE			50.8	mm	Core magnetic path length
137	AL			7350	nH/t ²	Ungapped core effective inductance per turns squared
138	VE			6655	mm ³	Core volume
139	BOBBIN NAME			TBI-238-03381.12XX		Bobbin name
140	AW			51.0	mm ²	Bobbin window area
141	BW			10.40	mm	Bobbin width
142	MARGIN			0.0	mm	Bobbin safety margin
144	PRIMARY WINDING					
145	NPRIMARY			35		Primary winding number of turns
146	BPEAK			3686	Gauss	Peak flux density
147	BMAX			3111	Gauss	Maximum flux density
148	BAC			1476	Gauss	AC flux density (0.5 x Peak to Peak)
149	ALG			457	nH/t ²	Typical gapped core effective inductance per turns squared
150	LG			0.338	mm	Core gap length
151	LAYERS_PRIMARY	2		2		Primary winding number of layers
152	AWG_PRIMARY			24		Primary wire gauge
153	OD_PRIMARY_INSULATED			0.577	mm	Primary wire insulated outer diameter
154	OD_PRIMARY_BARE			0.511	mm	Primary wire bare outer diameter
155	CMA_PRIMARY			356.1	Cmils/A	Primary winding wire CMA
156						
157	SECONDARY WINDING					
158	NSECONDARY	5		5		Secondary winding number of turns
159	AWG_SECONDARY			18		Secondary wire gauge
160	OD_SECONDARY_INSULATED			1.328	mm	Secondary wire insulated outer diameter
161	OD_SECONDARY_BARE			1.024	mm	Secondary wire bare outer diameter
162	CMA_SECONDARY			210.1	Cmils/A	Secondary winding wire CMA
164	BIAS WINDING					
165	NBIAS			10		Bias winding number of turns

169	PRIMARY COMPONENTS SELECTION					
170	LINE UNDERVOLTAGE					
171	BROWN-IN REQUIRED	76.00		76.00	V	Required line brown-in threshold
172	RLS			4.00	MΩ	Connect two 2 MOhm resistors to the V-pin for the required UV/OV threshold
173	BROWN-IN ACTUAL			75.98	V	Actual brown-in threshold using standard resistors
174	BROWN-OUT ACTUAL			66.93	V	Actual brown-out threshold using standard resistors
175						
176	LINE OVERVOLTAGE					
177	OVERVOLTAGE_LINE		Warning	334.21	V	The device voltage stress will be higher than 650V when overvoltage is triggered
179	BIAS WINDING					
180	VBIAS			9.00	V	Rectified bias voltage at the cable disconnect (5V) set-point
181	VF_BIAS			0.70	V	Bias winding diode forward drop
182	VREVERSE_BIASDIODE			115.66	V	Bias diode reverse voltage (not accounting parasitic voltage ring)
183	CBIAS			22	uF	Bias winding rectification capacitor
184	CBPP			4.70	uF	BPP pin capacitor
188	SECONDARY COMPONENTS SELECTION					
189	RECTIFIER					
190	VDRAIN_OFF_SRFET			74.33	V	Secondary rectifier reverse voltage (not accounting parasitic voltage ring)
191	SRFET	AON6220		AON6220		Secondary rectifier (Logic MOSFET)
192	VBREAKDOWN_SRFET			100	V	Secondary rectifier breakdown voltage
193	RDSON_SRFET			7.4	mΩ	SRFET on time drain resistance at 25degC for VGS=4.4V

Note: The warnings on the spreadsheet have been verified to not be an issue for this design. For line 177 (OVERVOLTAGE_LINE), the InnoSwitch3-PD INN3870C-H805 is a 750 V device.

12 Performance Data

- Note:** 1. Output voltage measured on the PCB unless otherwise specified.
2. For data points showing performance across varying input line voltage and output load current, measurements were taken from full load to no load, with input line voltage from low-line to high-line, at room temperature ambient (approximately 25 °C) unless otherwise specified.

12.1 No-Load Input Power

- Note:** 1. Unit tested without Type-C cable connected to output.
2. For each line voltage, soak time = 10 min and integration time = 5 min.

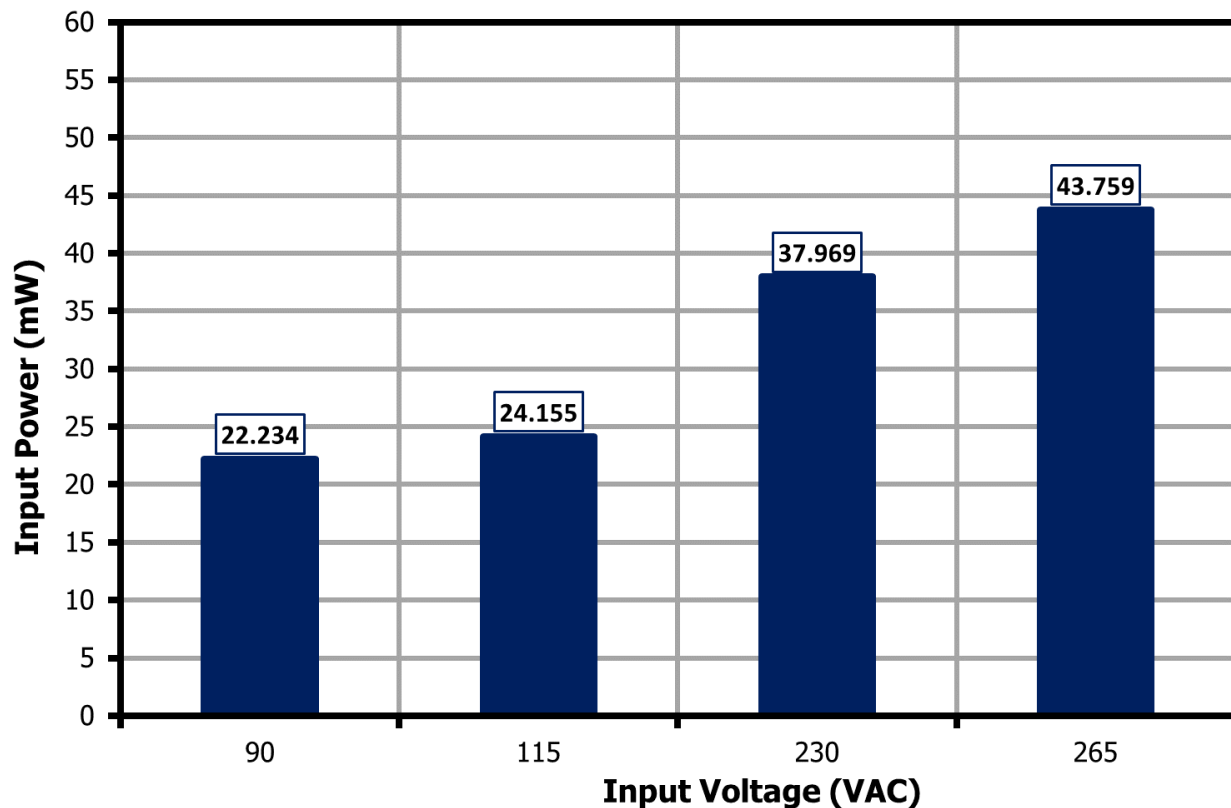

Figure 15 – No-Load Input Power vs. Input Line Voltage.

12.2 Full Load Efficiency (On-board)

V _{OUT} (V)	Load (A)	Power (W)	Full Load Efficiency (%)			
			90 VAC	115 VAC	230 VAC	265 VAC
5	5.0	25	90.87	91.52	92.58	92.30
9	5.0	45	91.34	92.18	93.26	93.06
12	5.0	60	91.14	92.21	93.63	93.52
15	5.0	75	91.30	91.80	92.53	92.87
20	5.0	100	91.04	91.89	93.32	93.41

12.3 Average and 10% Load Efficiency

Measurements were taken after 30-minute delay per input line voltage and 1-minute delay per load condition. Output voltage was measured on the board.

12.3.1 Efficiency Requirements

		Test	Average Efficiency (%)		10% Load Efficiency (%)
			Effective	2016	Jan-16
V _{OUT} (V)	Model (V)	Power (W)	New EISA2007	CoC v5 Tier 2	CoC v5 Tier 2
5	<6	25	84.25	85.00	73.18
9	>6	45	87.73	88.85	78.43
12	>6	60	88.00	89.00	79.00
15	>6	75	88.00	89.00	79.00
20	>6	100	88.00	89.00	79.00

12.3.2 Efficiency Performance Summary (On Board)

V _{OUT} (V)	Power (W)	Average Efficiency (%)		10% Load Efficiency (%)	
		115 VAC	230 VAC	115 VAC	230 VAC
5	25	92.10	91.47	90.95	87.44
9	45	92.60	92.77	90.97	88.32
12	60	92.64	93.17	90.80	88.70
15	75	91.87	91.97	90.50	88.86
20	100	91.30	91.32	89.96	88.99

12.3.3 Average and 10% Load Efficiency Measurements

12.3.3.1 Output: 5 V / 5 A

Input (VAC)	Load (%)	Design Performance					Efficiency Standards		Remarks	
		P _{IN} (W)	V _{OUT} (V)	I _{OUT} (A)	P _{OUT} (W)	Efficiency (%)	Average Efficiency (%)	DOE6 (%)		CoC v5 Tier 2 (%)
115	100	26.970	4.935	5.002	24.683	91.52	92.10	84.25	85.00	PASS
	75	20.190	4.958	3.752	18.599	92.12				
	50	13.450	4.974	2.501	12.441	92.50				
	25	6.756	4.985	1.251	6.234	92.27				
	10	2.752	5.003	0.500	2.503	90.95				
230	100	26.770	4.955	5.002	24.785	92.58	91.47	84.25	85.00	PASS
	75	20.280	4.968	3.752	18.636	91.89				
	50	13.610	4.980	2.501	12.456	91.52				
	25	6.940	4.989	1.251	6.238	89.88				
	10	2.867	5.011	0.500	2.507	87.44				

12.3.3.2 Output: 9 V / 5 A

Input (VAC)	Load (%)	Design Performance					Efficiency Standards		Remarks	
		P _{IN} (W)	V _{OUT} (V)	I _{OUT} (A)	P _{OUT} (W)	Efficiency (%)	Average Efficiency (%)	DOE6 (%)		CoC v5 Tier 2 (%)
115	100	48.480	8.934	5.002	44.687	92.18	92.60	87.73	88.85	PASS
	75	36.310	8.960	3.751	33.612	92.57				
	50	24.180	8.982	2.501	22.464	92.90				
	25	12.125	8.994	1.251	11.247	92.76				
	10	4.949	8.999	0.500	4.502	90.97				
230	100	48.010	8.951	5.002	44.773	93.26	92.77	87.73	88.85	PASS
	75	36.150	8.981	3.752	33.693	93.20				
	50	24.180	8.991	2.501	22.487	93.00				
	25	12.280	8.995	1.251	11.249	91.60				
	10	5.102	9.004	0.500	4.506	88.32				

12.3.3.3 Output: 12 V / 5 A

Input (VAC)	Load (%)	Design Performance					Efficiency Standards		Remarks	
		P _{IN} (W)	V _{OUT} (V)	I _{OUT} (A)	P _{OUT} (W)	Efficiency (%)	Average Efficiency (%)	DOE6 (%)		CoC v5 Tier 2 (%)
115	100	64.680	11.926	5.001	59.643	92.21	92.64	88.00	89.00	PASS
	75	48.340	11.953	3.751	44.837	92.75				
	50	32.250	11.974	2.501	29.941	92.84				
	25	16.160	11.989	1.250	14.989	92.75				
	10	6.601	11.989	0.500	5.994	90.80		79.00	PASS	
230	100	63.800	11.944	5.001	59.733	93.63	93.17	88.00	89.00	PASS
	75	48.030	11.978	3.751	44.930	93.55				
	50	32.100	11.986	2.501	29.971	93.37				
	25	16.270	11.991	1.250	14.991	92.14				
	10	6.760	11.993	0.500	5.996	88.70		79.00	PASS	

12.3.3.4 Output: 15 V / 5 A

Input (VAC)	Load (%)	Design Performance					Efficiency Standards		Remarks	
		P _{IN} (W)	V _{OUT} (V)	I _{OUT} (A)	P _{OUT} (W)	Efficiency (%)	Average Efficiency (%)	DOE6 (%)		CoC v5 Tier 2 (%)
115	100	81.400	14.942	5.001	74.723	91.80	91.87	88.00	89.00	PASS
	75	61.310	14.983	3.751	56.200	91.67				
	50	41.050	14.988	2.501	37.477	91.30				
	25	20.210	14.988	1.250	18.737	92.71				
	10	8.284	14.994	0.500	7.497	90.50		79.00	PASS	
230	100	80.760	14.943	5.001	74.730	92.53	91.97	88.00	89.00	PASS
	75	61.100	14.984	3.751	56.205	91.99				
	50	41.210	14.989	2.501	37.481	90.95				
	25	20.280	14.994	1.250	18.744	92.43				
	10	8.440	15.000	0.500	7.500	88.86		79.00	PASS	

12.3.3.5 Output: 20 V / 5 A

Input (VAC)	Load (%)	Design Performance					Efficiency Standards		Remarks	
		P _{IN} (W)	V _{OUT} (V)	I _{OUT} (A)	P _{OUT} (W)	Efficiency (%)	Average Efficiency (%)	DOE6 (%)		CoC v5 Tier 2 (%)
115	100	108.490	19.935	5.001	99.690	91.89	91.30	88.00	89.00	PASS
	75	81.630	19.964	3.751	74.880	91.73				
	50	54.560	19.969	2.500	49.930	91.51				
	25	27.725	19.973	1.250	24.968	90.06				
	10	11.096	19.967	0.500	9.982	89.96				
230	100	106.800	19.930	5.001	99.670	93.32	91.32	88.00	89.00	PASS
	75	80.950	19.958	3.751	74.850	92.46				
	50	54.510	19.967	2.500	49.920	91.58				
	25	28.400	19.971	1.250	24.966	87.91				
	10	11.220	19.971	0.500	9.985	88.99				

12.4 Efficiency Across Line at 100% Load (On Board)

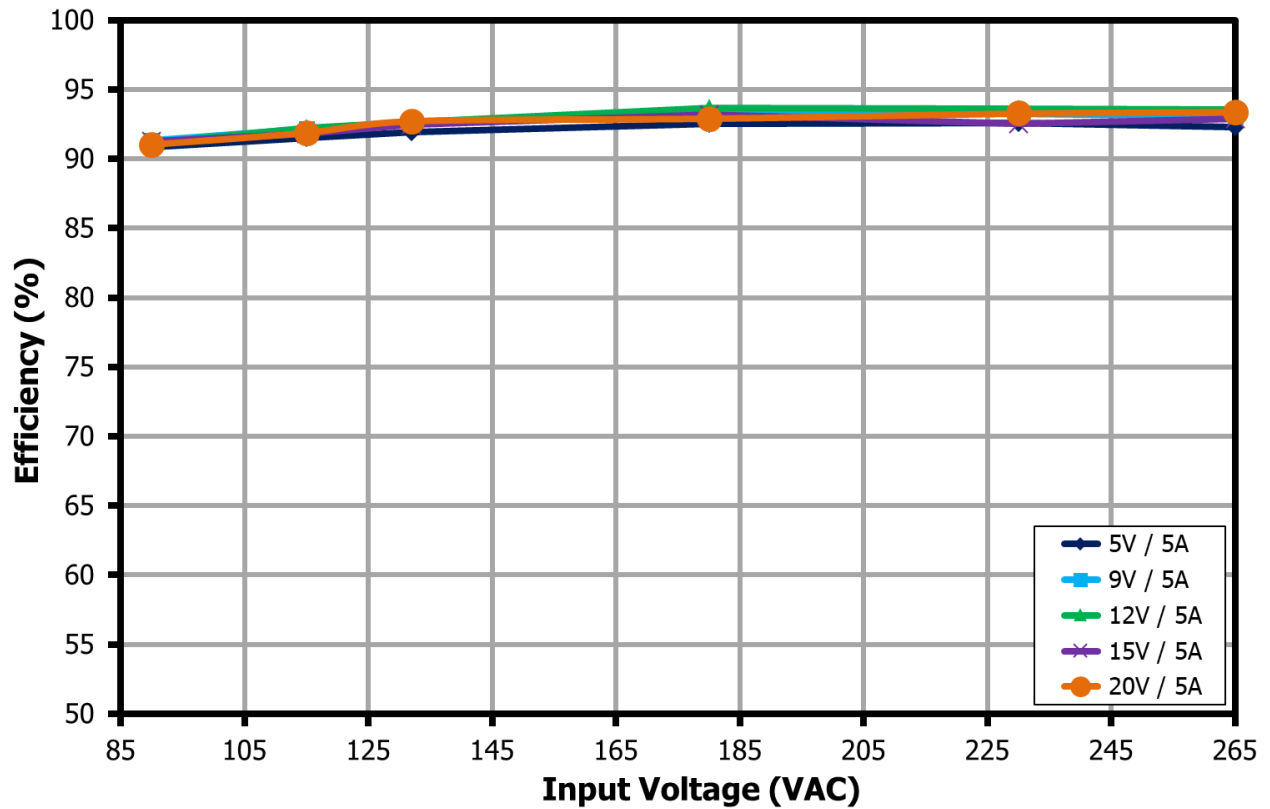

Figure 16 – Full Load Efficiency vs. Input Line for 5 V, 9 V, 12 V, 15 V, and 20 V Output, Room Temperature.

12.5 Efficiency Across Load (On Board)

Note: 1. The PFC bias circuit has been configured to operate as discussed in Section 4.2. Improvement in efficiency is expected for operating conditions wherein the PFC stage is disabled.

12.5.1 Output: 5 V / 5 A

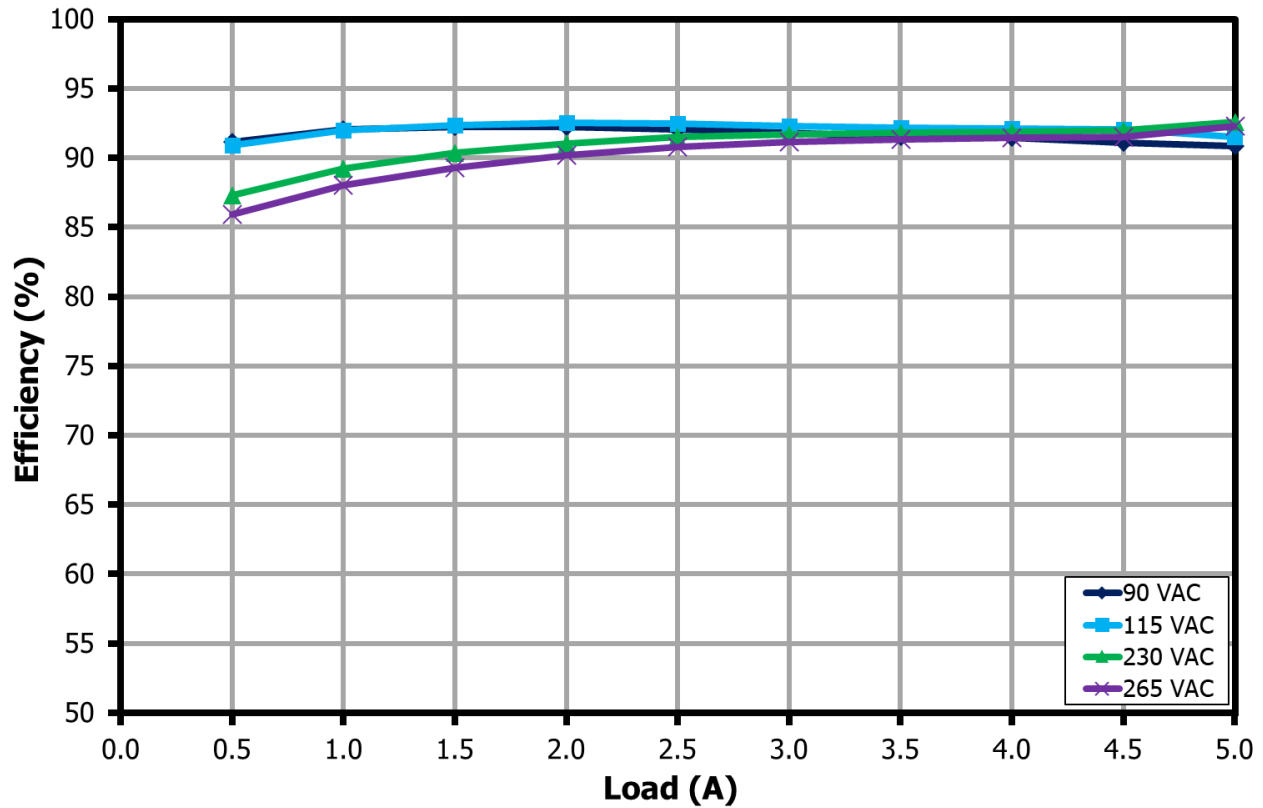

Figure 17 – Efficiency vs. Load for 5 V Output, Room Temperature.

12.5.2 Output: 9 V / 5 A

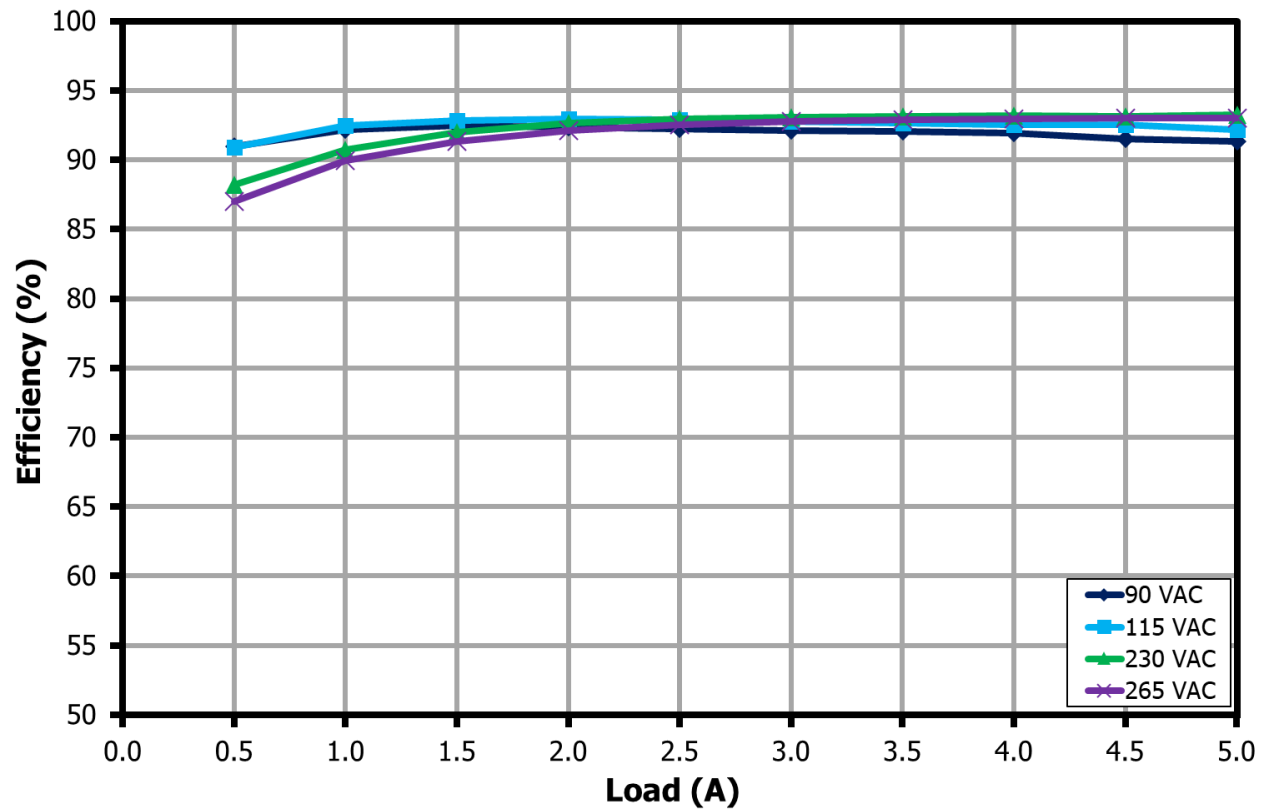

Figure 18 – Efficiency vs. Load for 9 V Output, Room Temperature.

12.5.3 Output: 12 V / 5 A

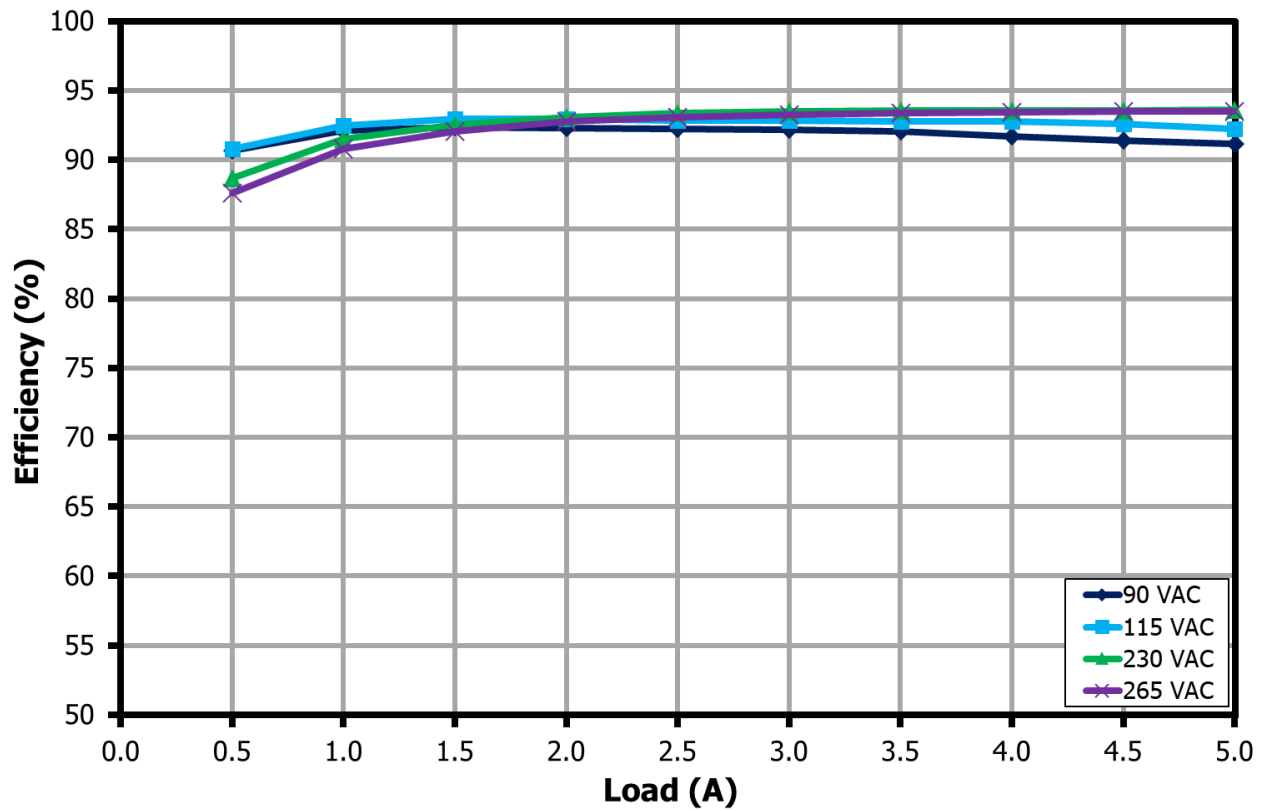

Figure 19 – Efficiency vs. Load for 12 V Output, Room Temperature.

12.5.4 Output: 15 V / 5 A

12.5.4.1 Output: 15 V / 5 A (90 VAC)

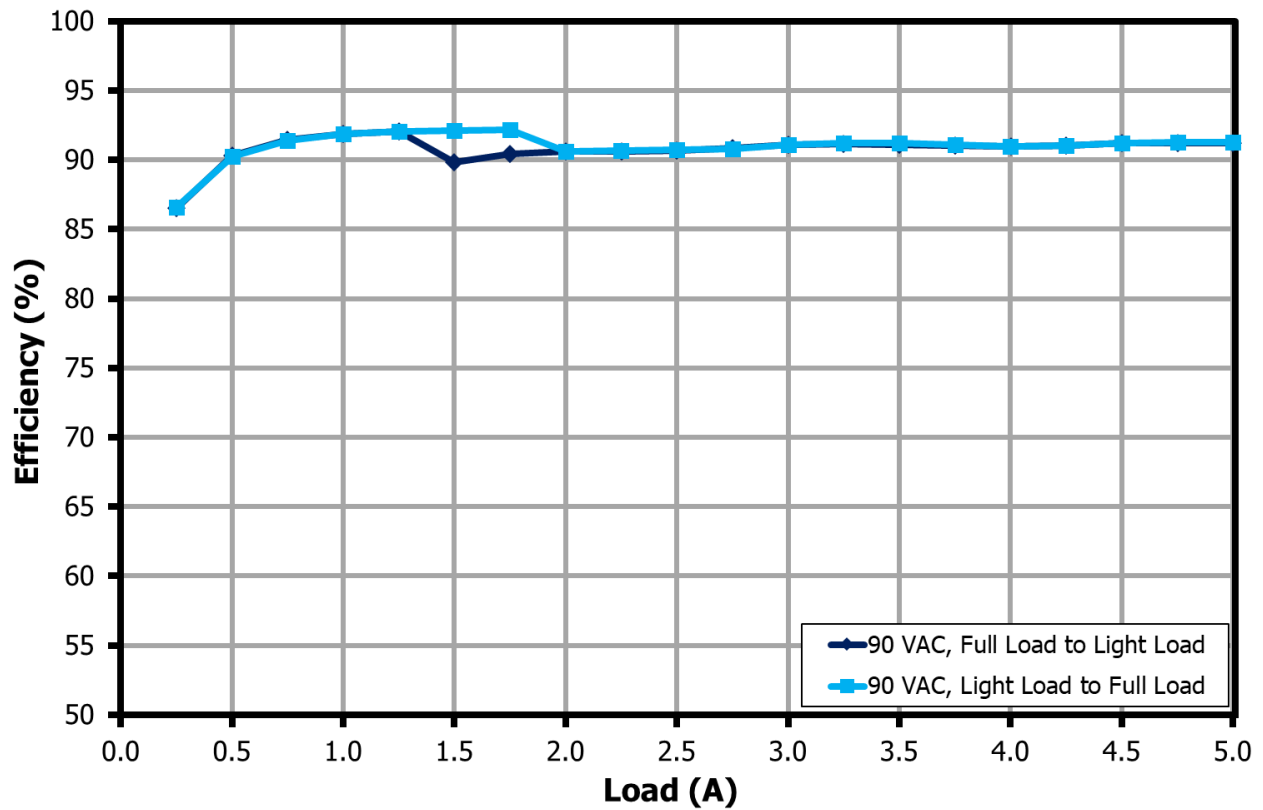

Figure 20 – Efficiency vs. Load for 15 V Output, 90 VAC, Room Temperature.

12.5.4.2 Output: 15 V / 5 A (115 VAC)

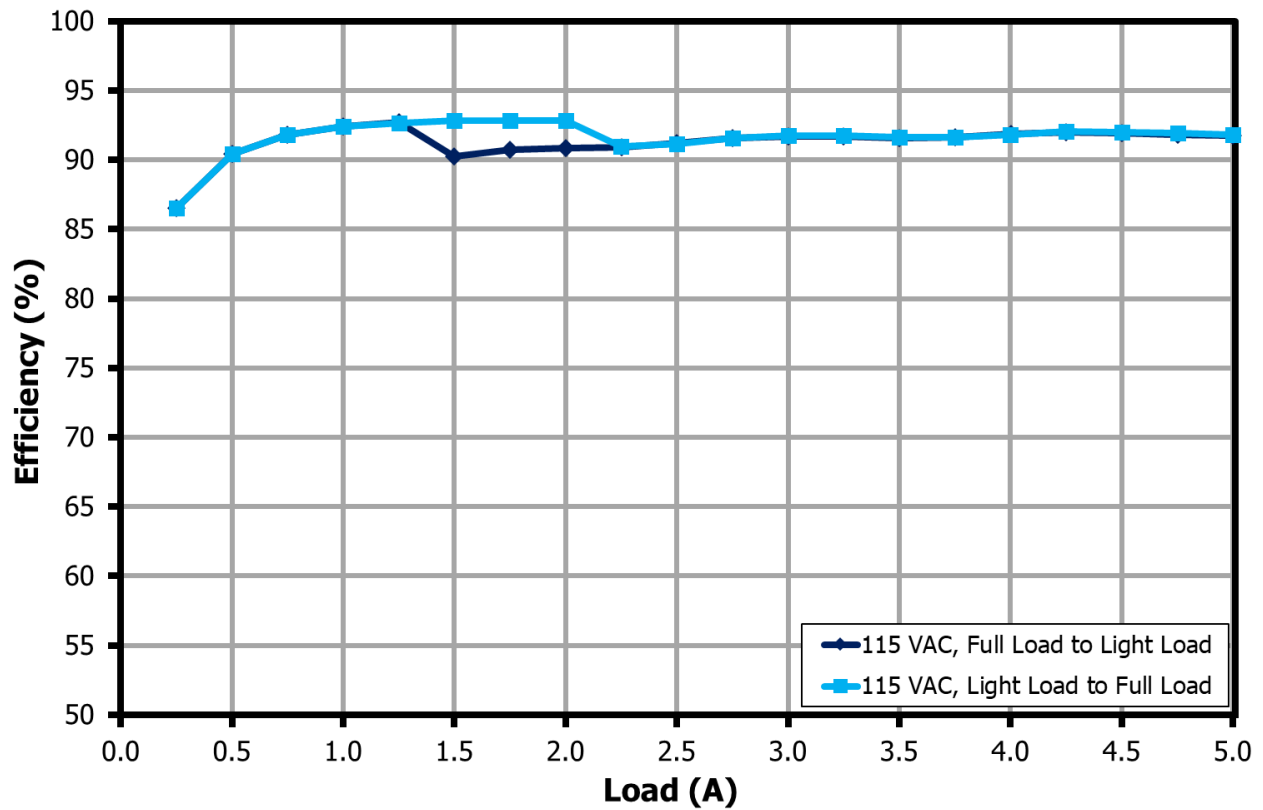

Figure 21 – Efficiency vs. Load for 15 V Output, 115 VAC, Room Temperature.

12.5.4.3 Output: 15 V / 5 A (230 VAC)

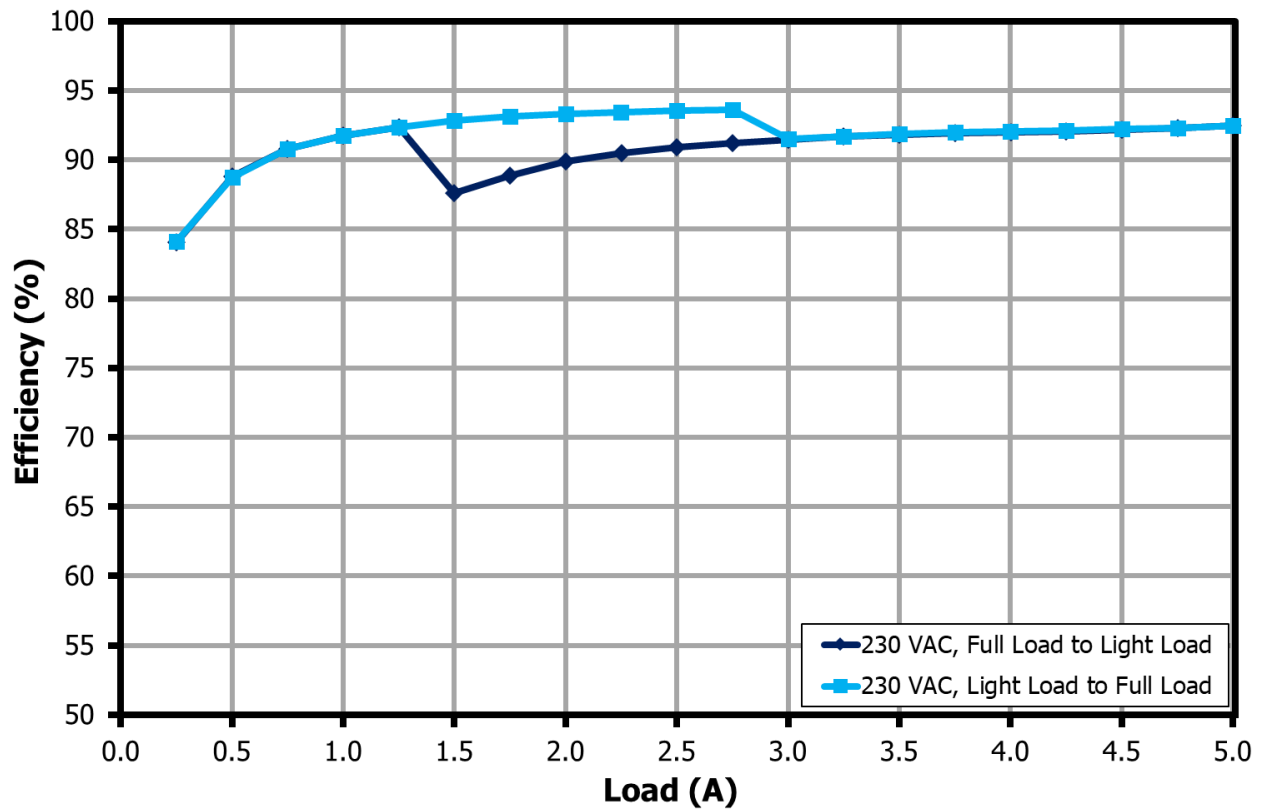

Figure 22 – Efficiency vs. Load for 15 V Output, 230 VAC, Room Temperature.

12.5.4.4 Output: 15 V / 5 A (265 VAC)

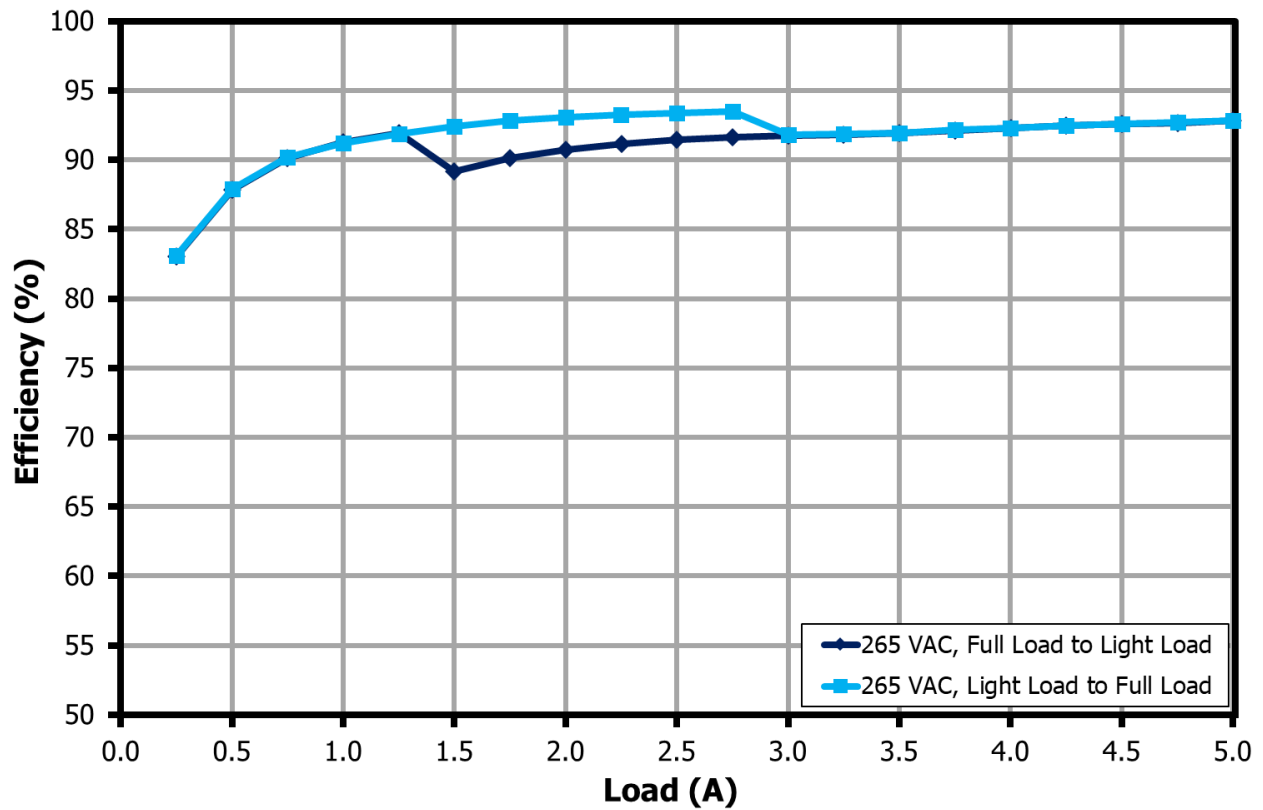

Figure 23 – Efficiency vs. Load for 15 V Output, 265 VAC, Room Temperature.

12.5.5 Output: 20 V / 5 A

12.5.5.1 Output: 20 V / 5 A (90 VAC)

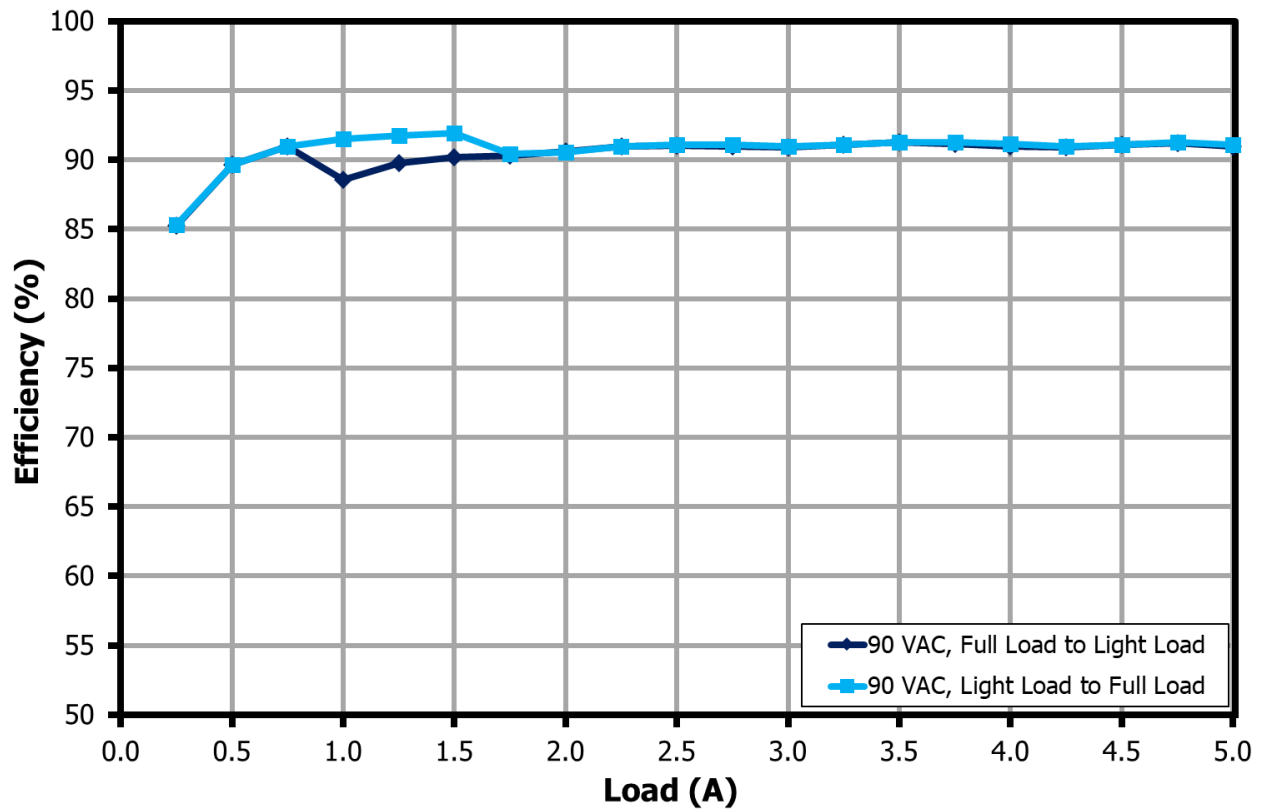

Figure 24 – Efficiency vs. Load for 20 V Output, 90 VAC, Room Temperature.

12.5.5.2 Output: 20 V / 5 A (115 VAC)

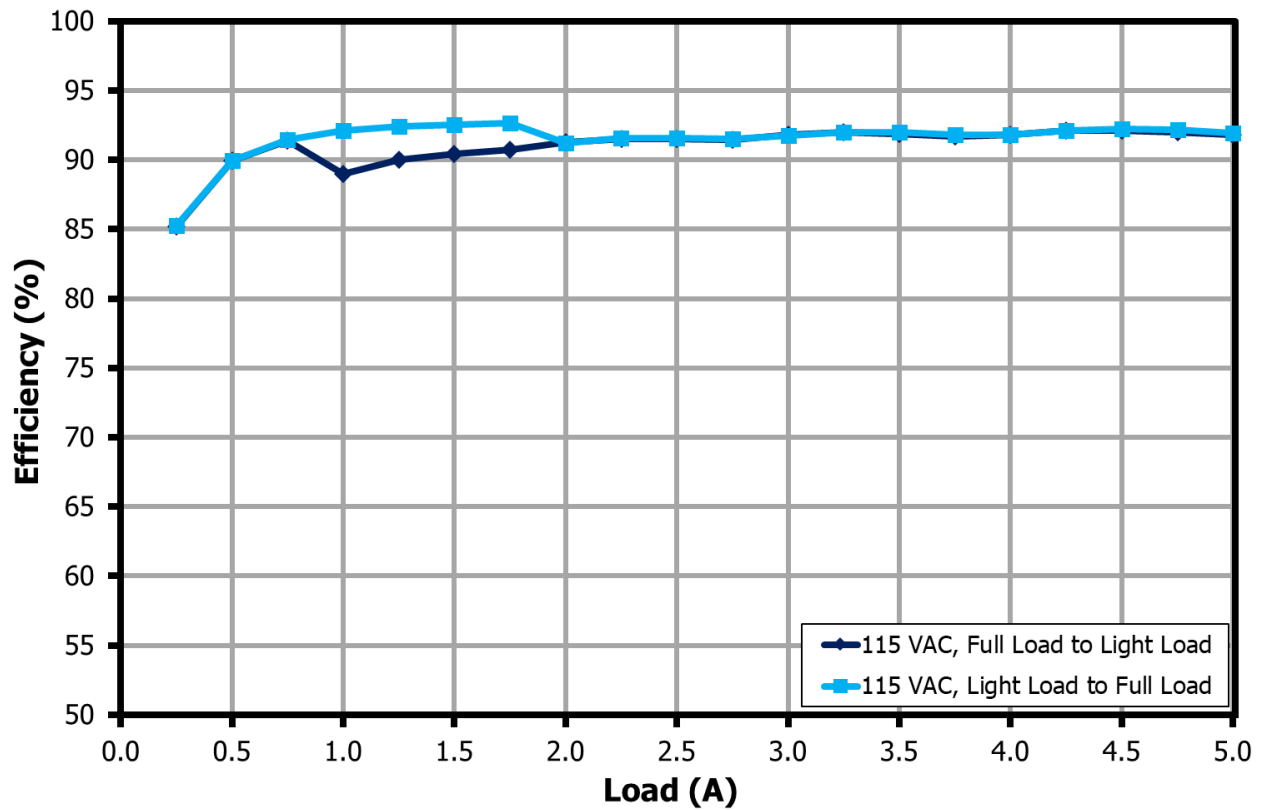

Figure 25 – Efficiency vs. Load for 20 V Output, 115 VAC, Room Temperature.

12.5.5.3 Output: 20 V / 5 A (230 VAC)

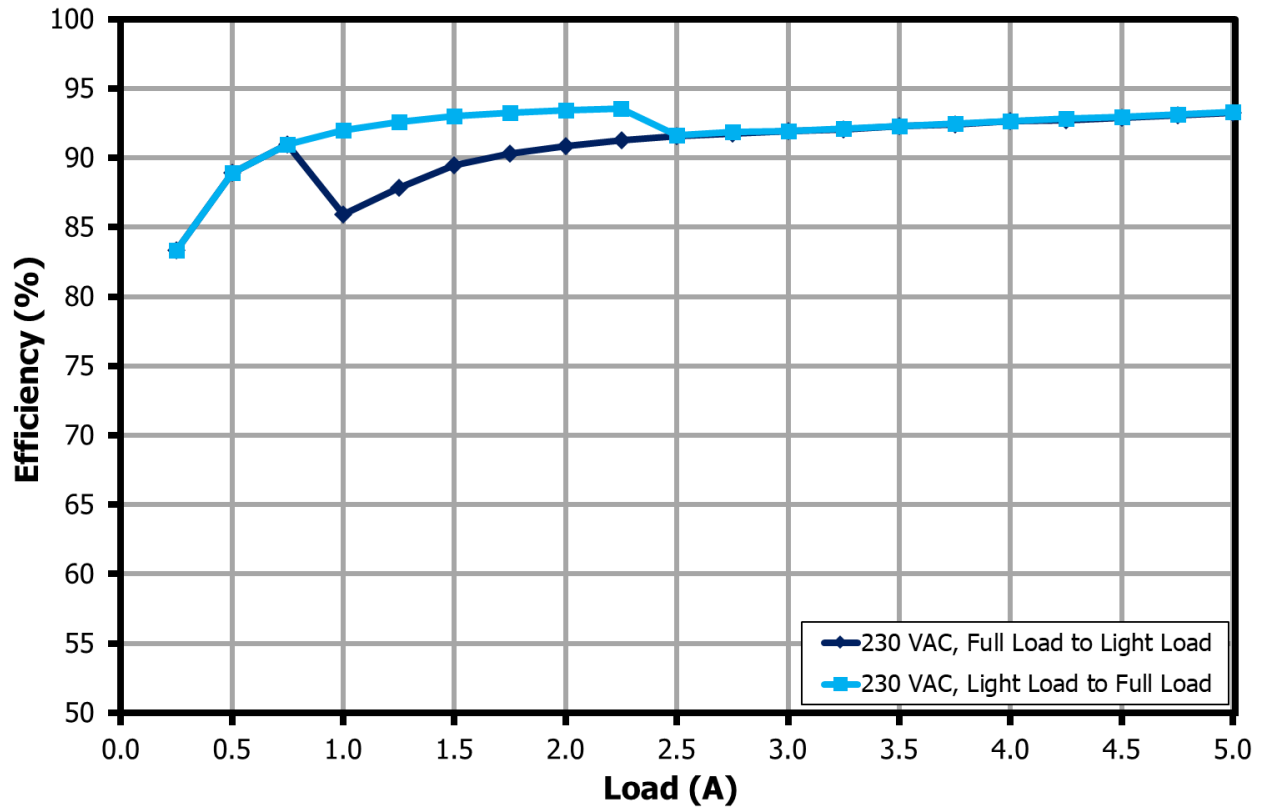

Figure 26 – Efficiency vs. Load for 20 V Output, 230 VAC, Room Temperature.

12.5.5.4 Output: 20 V / 5 A (265 VAC)

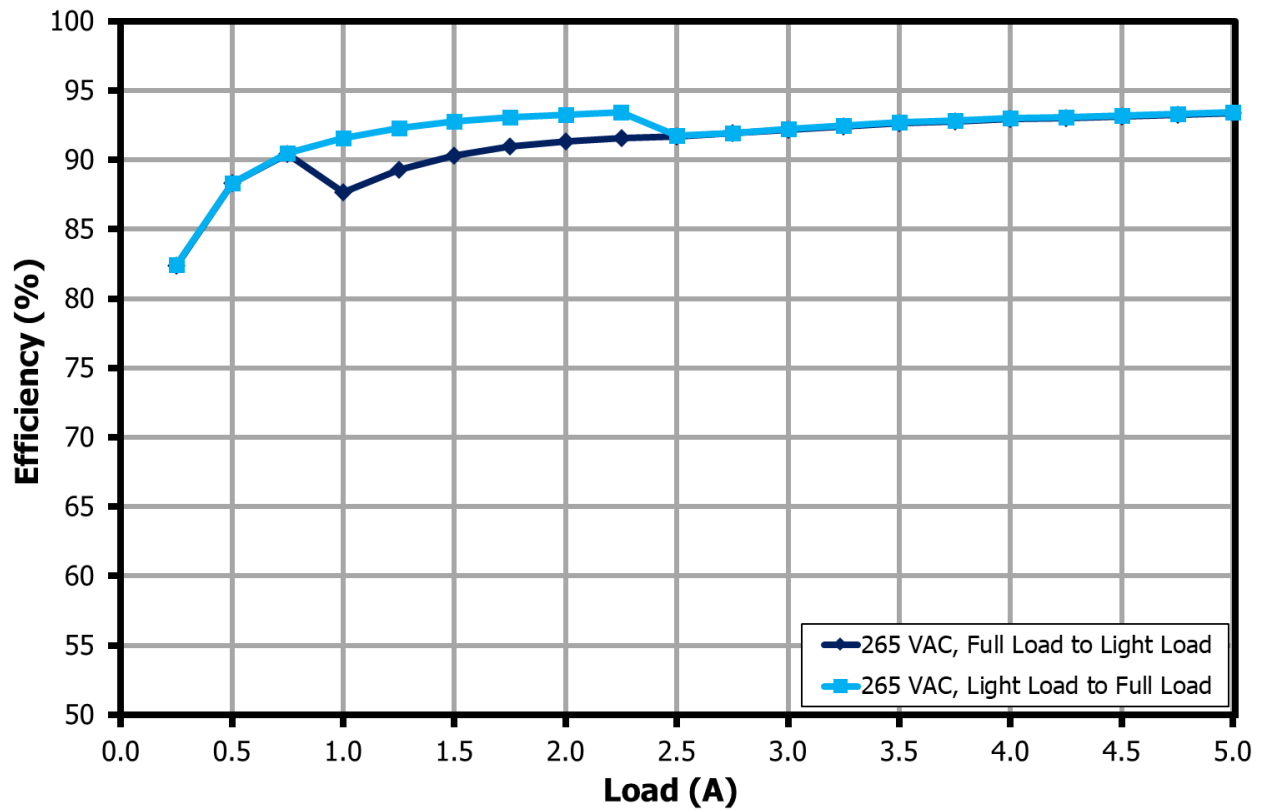

Figure 27 – Efficiency vs. Load for 20 V Output, 265 VAC, Room Temperature.

12.6 Load Regulation (On Board)

12.6.1 Output: 5 V / 5 A

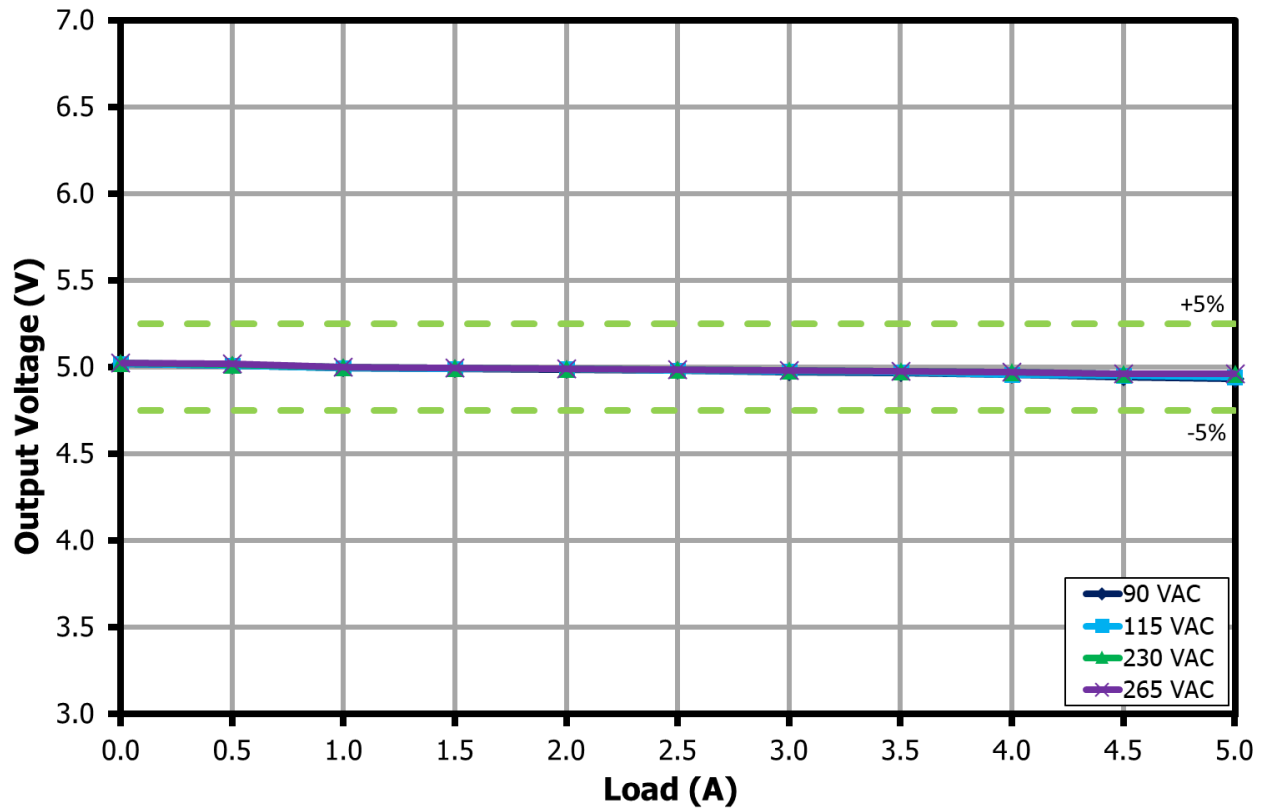

Figure 28 – Output Voltage vs. Output Load for 5 V Output, Room Temperature.

12.6.2 Output: 9 V / 5 A

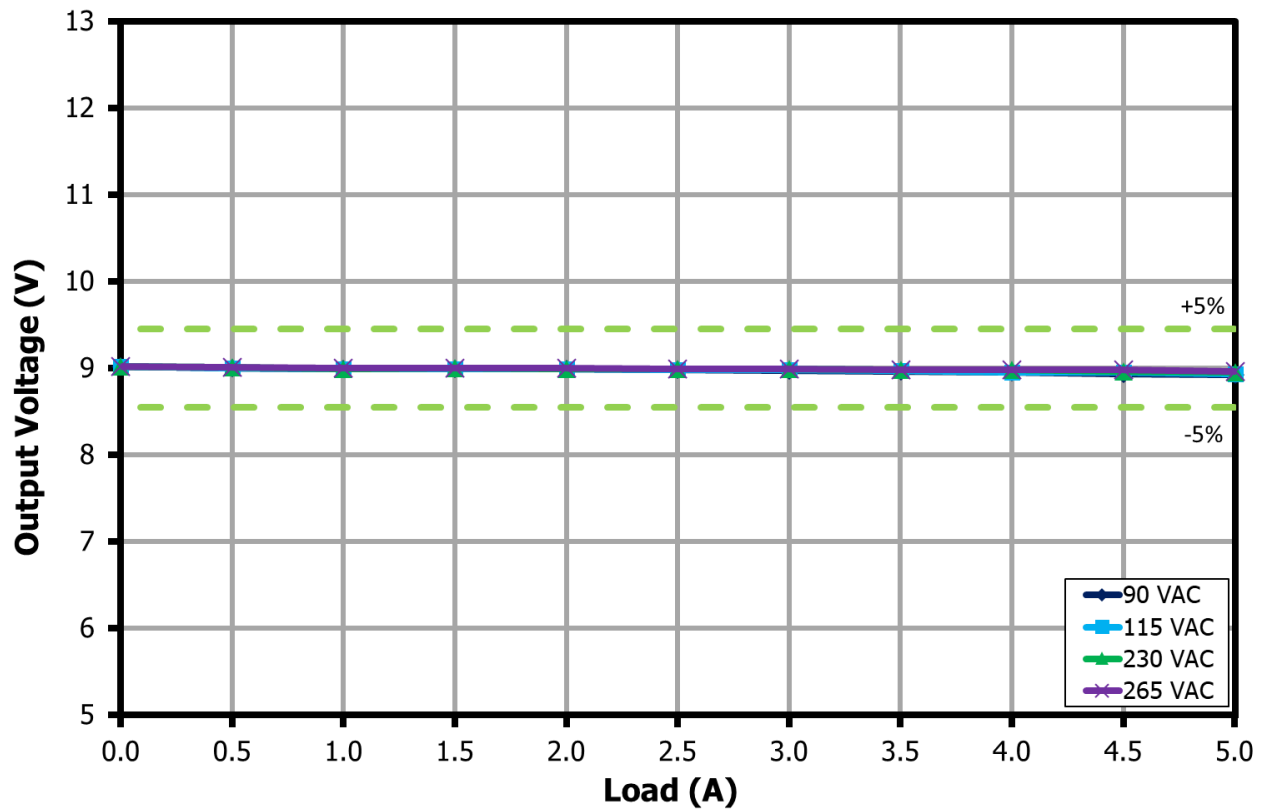

Figure 29 – Output Voltage vs. Output Load for 9 V Output, Room Temperature.

12.6.3 Output: 12 V / 5 A

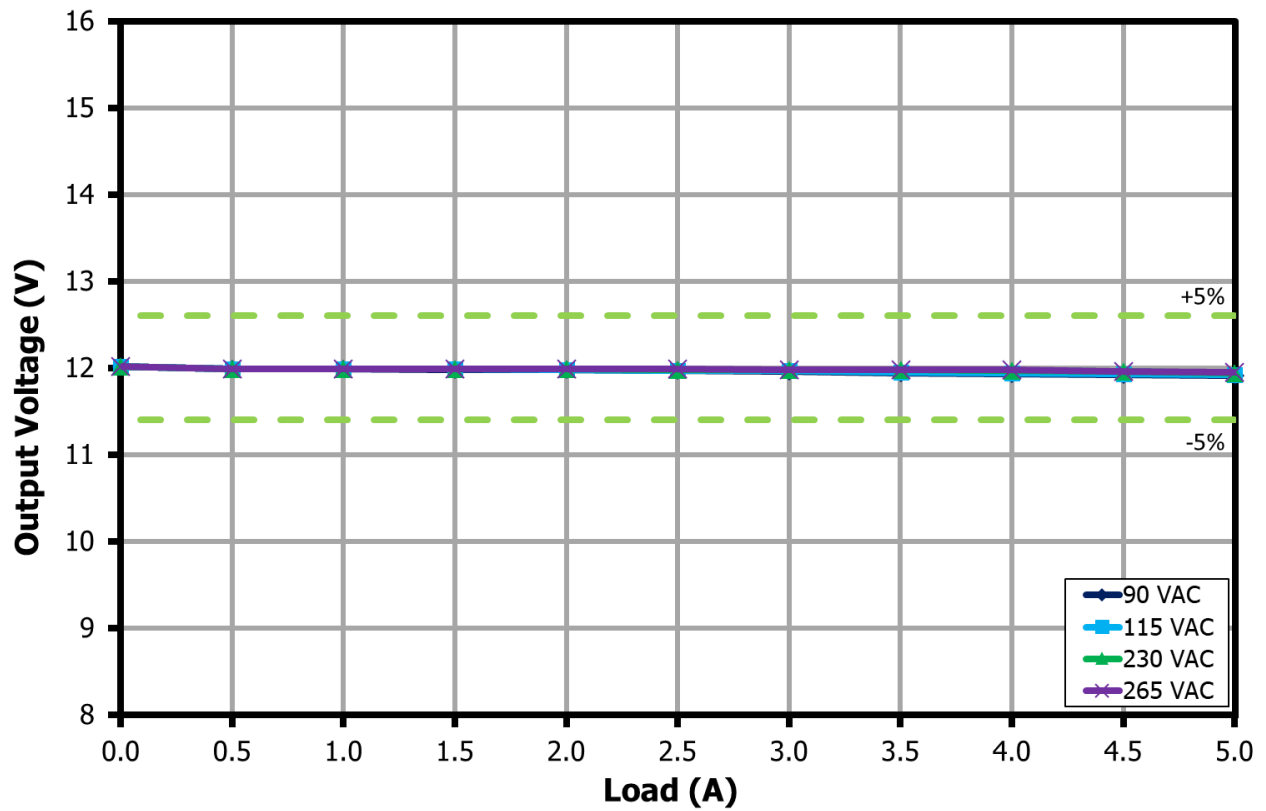

Figure 30 – Output Voltage vs. Output Load for 12 V Output, Room Temperature.

12.6.4 Output: 15 V / 5 A

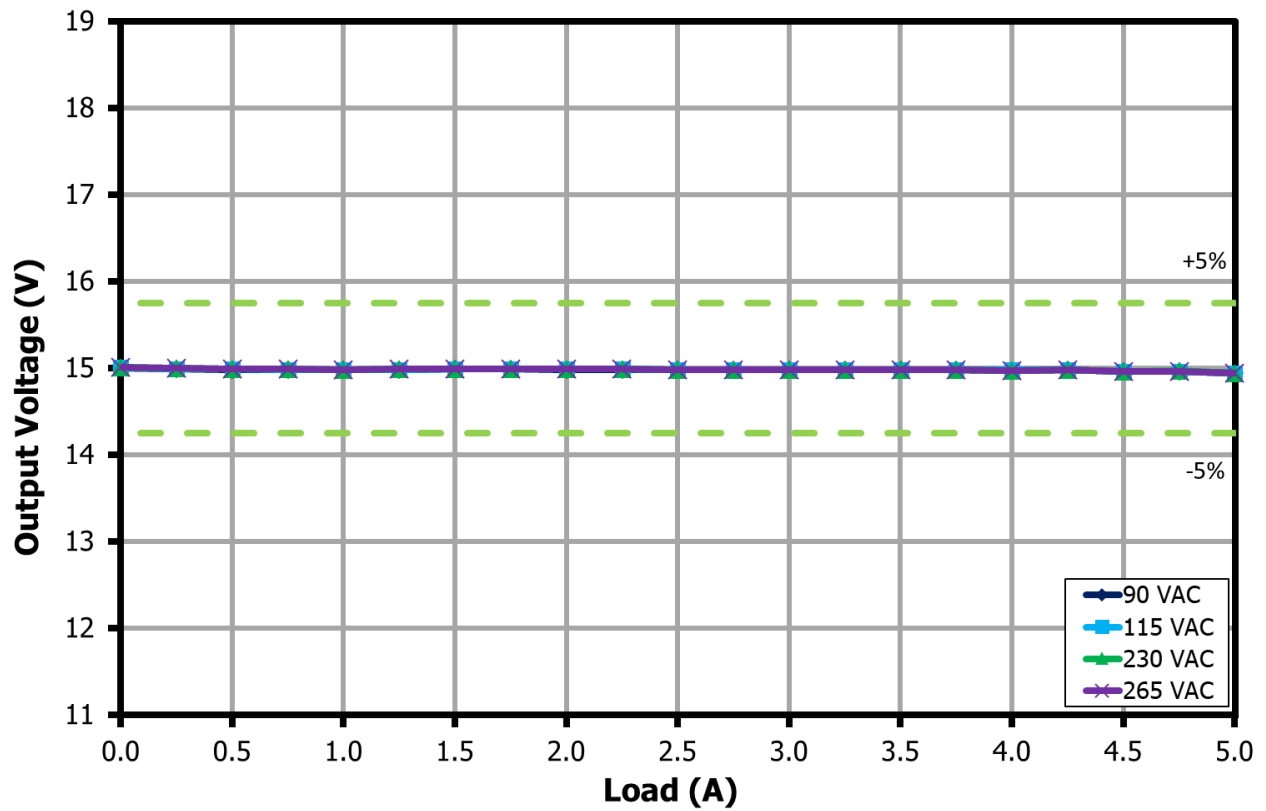

Figure 31 – Output Voltage vs. Output Load for 15 V Output, Room Temperature.

12.6.5 Output: 20 V / 5 A

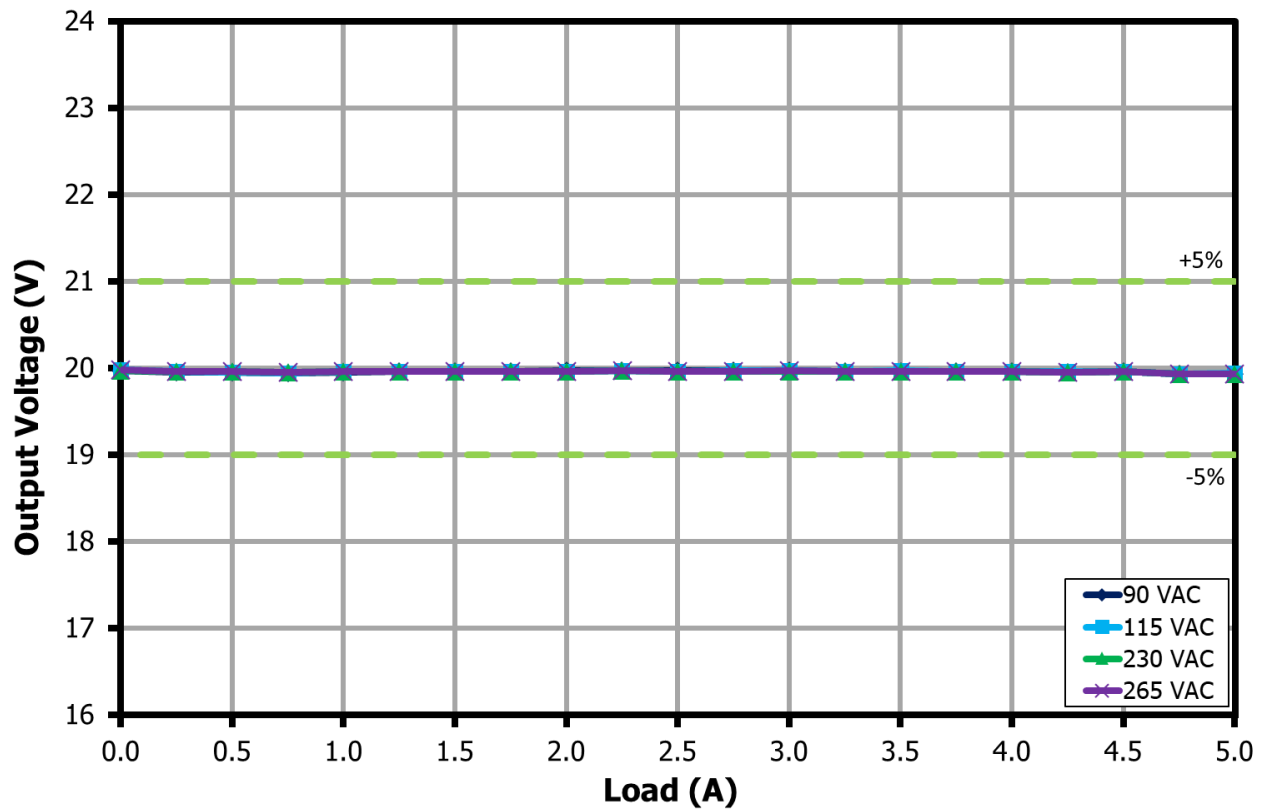

Figure 32 – Output Voltage vs. Output Load for 20 V Output, Room Temperature.

12.7 Line Regulation (On Board)

12.7.1 Output: 5 V / 5 A

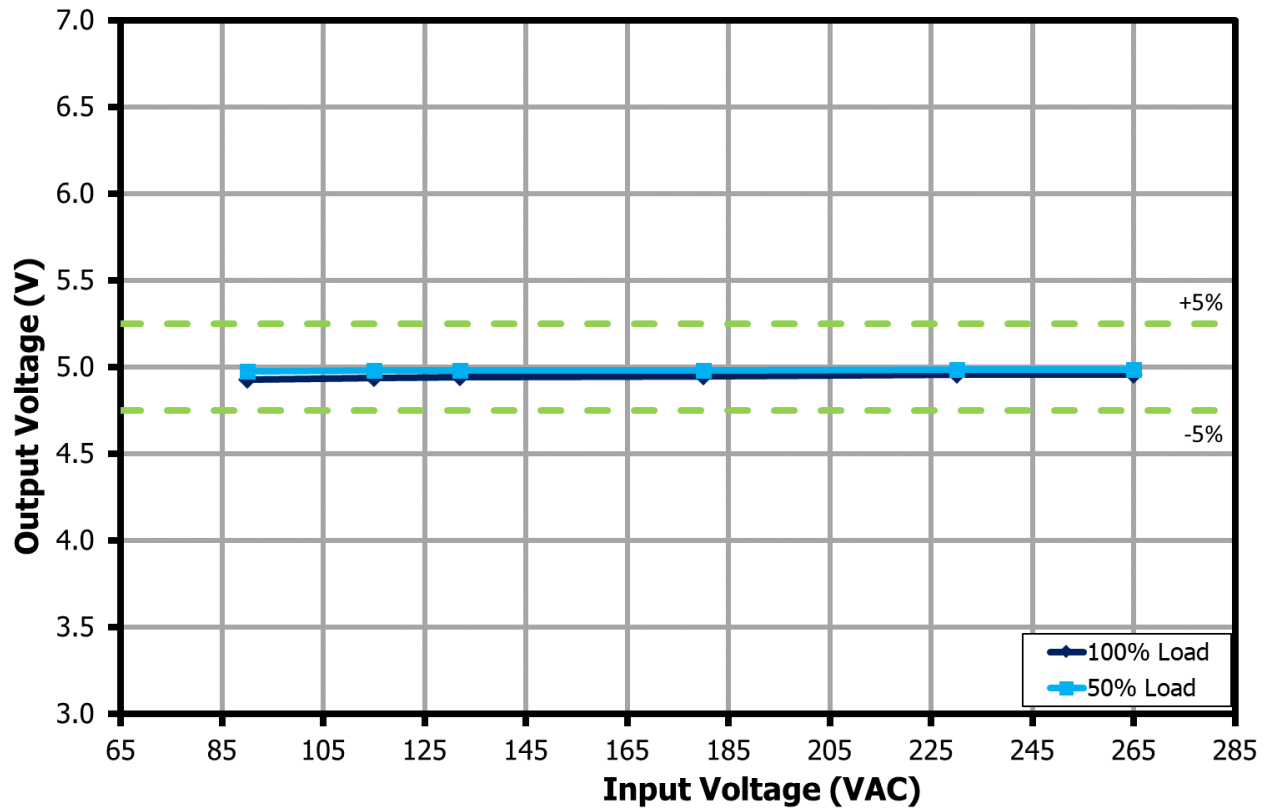

Figure 33 – Output Voltage vs. Input Line Voltage for 5 V Output, Room Temperature.

12.7.2 Output: 9 V / 5 A

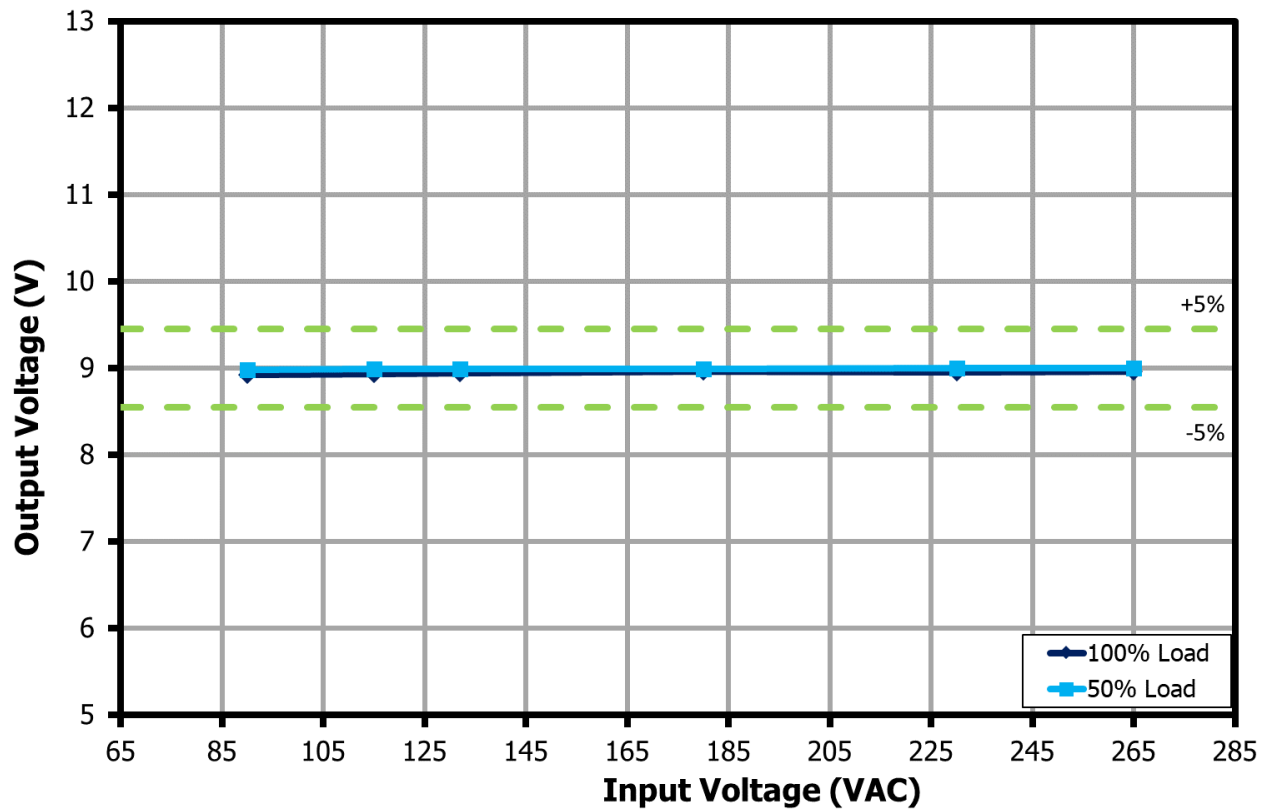

Figure 34 – Output Voltage vs. Input Line Voltage for 9 V Output, Room Temperature.

12.7.3 Output: 12 V / 5 A

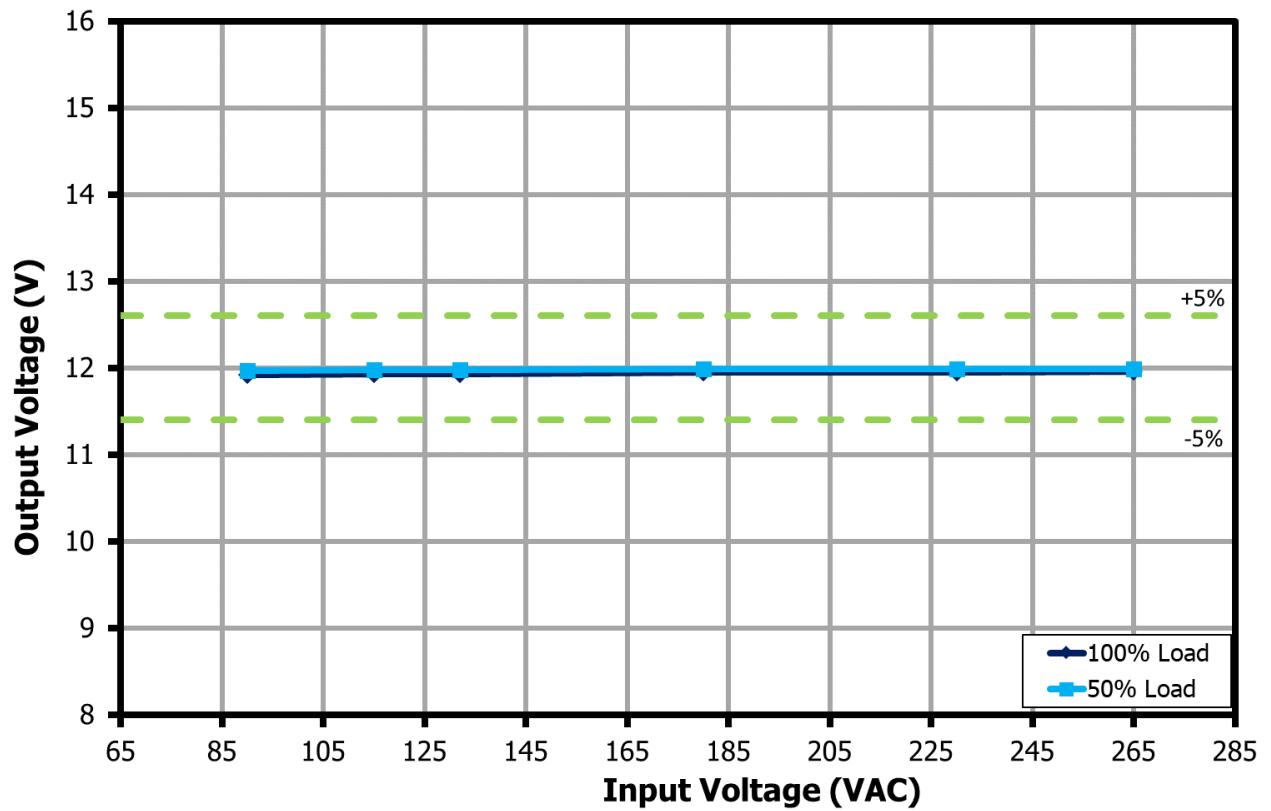

Figure 35 – Output Voltage vs. Input Line Voltage for 12 V Output, Room Temperature.

12.7.4 Output: 15 V / 5 A

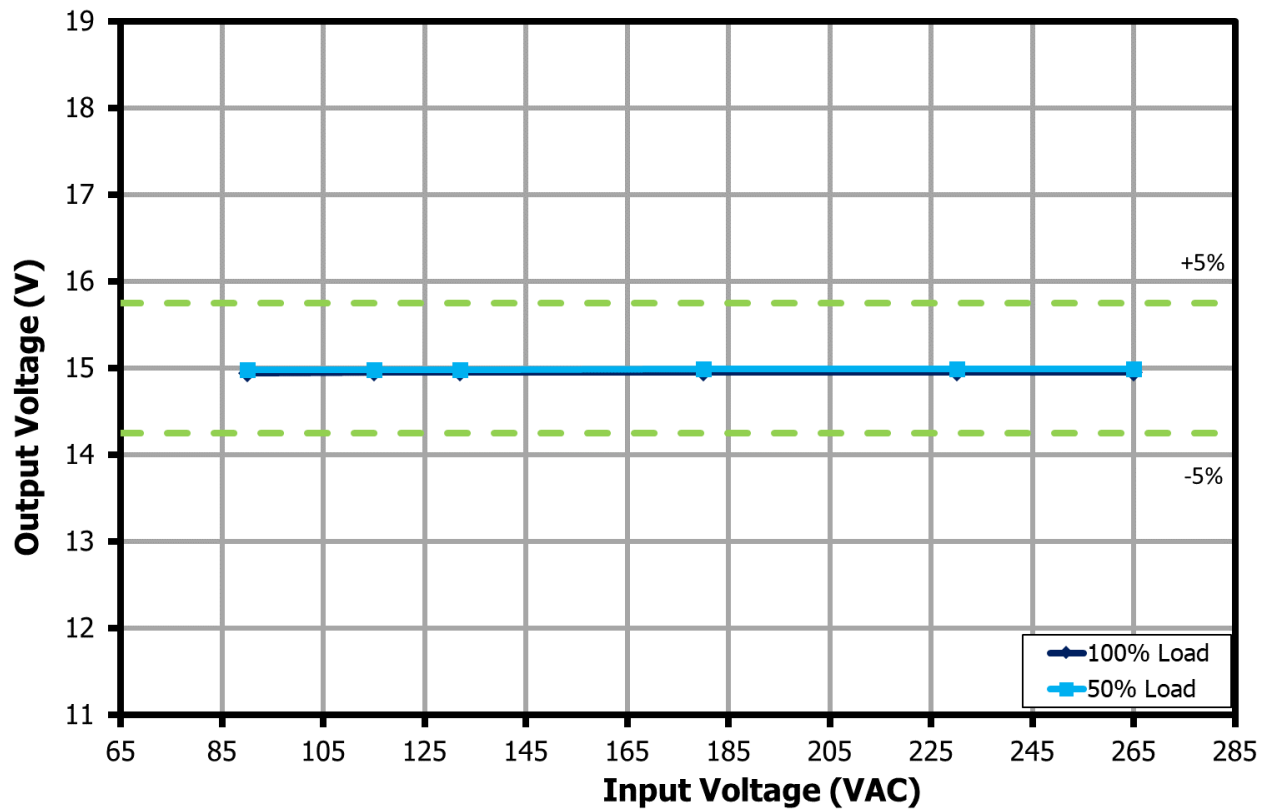

Figure 36 – Output Voltage vs. Input Line Voltage for 15 V Output, Room Temperature.

12.7.5 Output: 20 V / 5 A

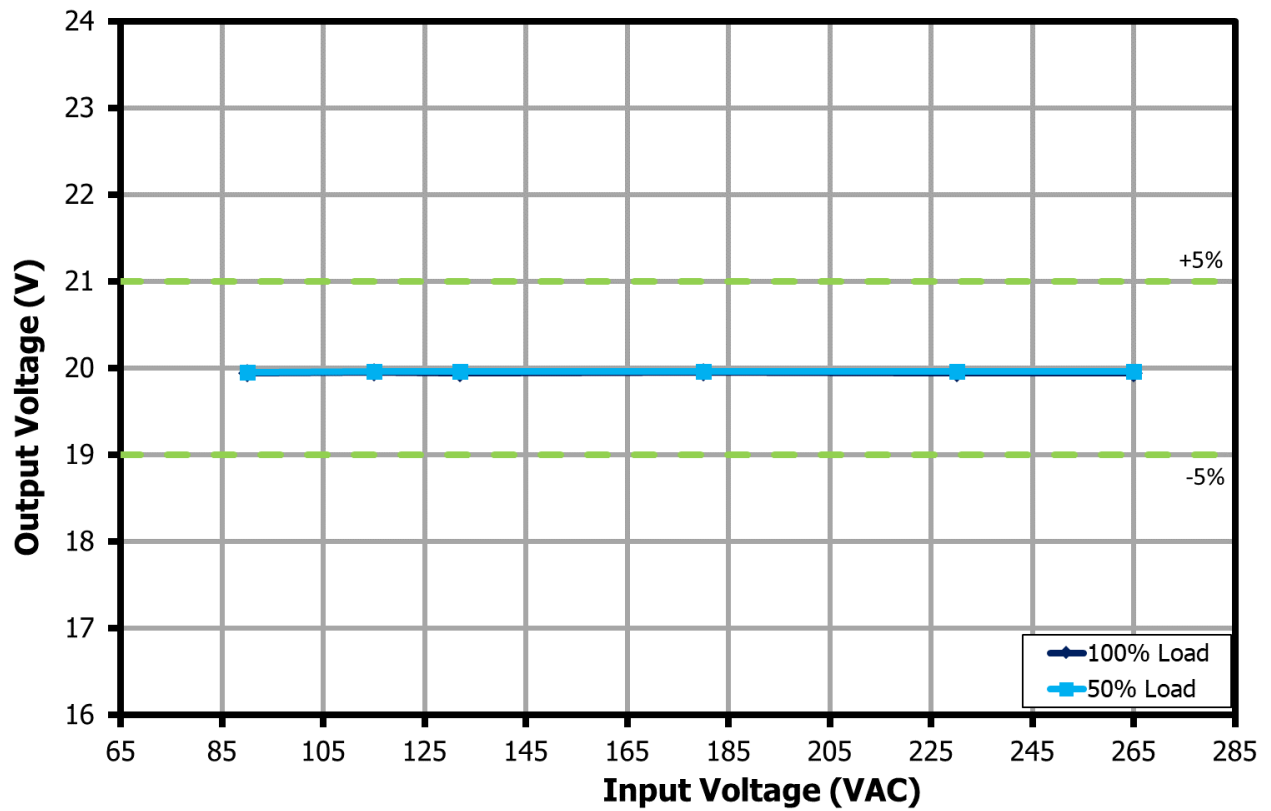

Figure 37 – Output Voltage vs. Input Line Voltage for 20 V Output, Room Temperature.

12.8 Input Current Harmonics

12.8.1 Output: 15 V / 5 A (115 VAC)

Input		Input Measurement					Output Measurement				
VAC _(RMS)	Freq (Hz)	V _{IN(RMS)}	I _{IN} (mA)	P _{IN} (W)	PF	% THD	V _{OUT} (V)	I _{OUT} (mA)	P _{OUT} (W)	%V Reg	Efficiency (%)
115	60	114.85	728.60	81.34	0.97	18.05	14.93	5001.10	74.69	0.44	91.82

Harmonic Order	Harmonic Content (mA)	Class D Limit (mA/W)	Class D Limit (mA)	Remarks
1	709.5			
3	115.5	3.40	276.59	Pass
5	44.3	1.90	154.57	Pass
7	21.0	1.00	81.35	Pass
9	12.8	0.50	40.68	Pass
11	12.4	0.35	28.47	Pass
13	3.7	0.30	24.09	Pass
15	3.5	0.26	20.88	Pass
17	5.9	0.23	18.42	Pass
19	8.1	0.20	16.48	Pass
21	8.8	0.18	14.91	Pass
23	8.8	0.17	13.62	Pass
25	8.9	0.15	12.53	Pass
27	6.1	0.14	11.60	Pass
31	5.9	0.12	10.10	Pass
31	5.9	0.12	10.10	Pass
33	3.4	0.12	9.49	Pass
35	4.9	0.11	8.95	Pass
37	4.1	0.10	8.46	Pass
39	2.5	0.10	8.03	Pass

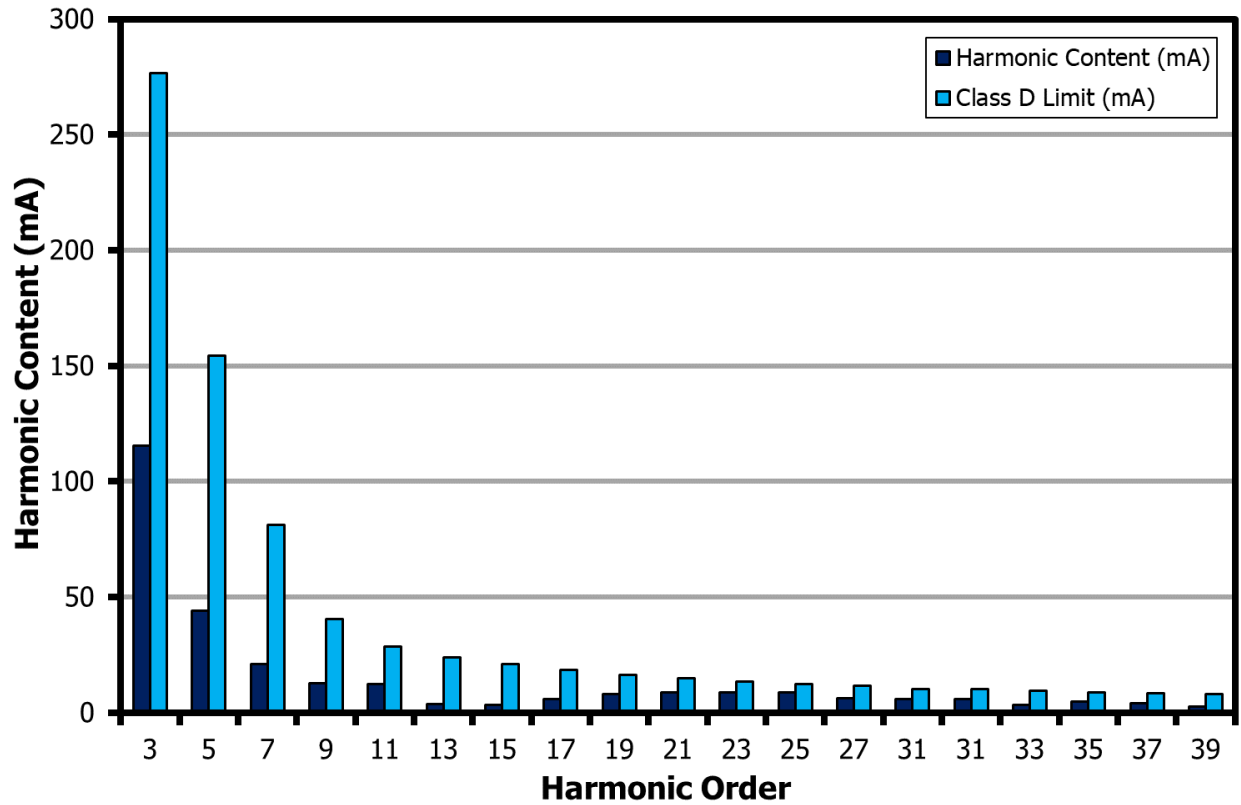

Figure 38 – Input Current Harmonics for 15 V Output, 5 A Load, 115 VAC, Room Temperature.

12.8.2 Output: 15 V / 5 A (230 VAC)

Input		Input Measurement					Output Measurement				
VAC _(RMS))	Freq (Hz)	V _{IN(RMS)}	I _{IN} (mA)	P _{IN} (W)	PF	% THD	V _{OUT} (V)	I _{OUT} (mA)	P _{OUT} (W)	%V Reg	Efficiency (%)
230	50	229.97	363.30	80.83	0.97	7.16	14.94	5001.00	74.72	0.40	92.44

Harmonic Order	Harmonic Content (mA)	Class D Limit (mA/W)	Class D Limit (mA)	Remarks
1	354.1			
3	9.7	3.40	274.72	Pass
5	10.5	1.90	153.52	Pass
7	6.3	1.00	80.80	Pass
9	10.7	0.50	40.40	Pass
11	10.1	0.35	28.28	Pass
13	6.5	0.30	23.93	Pass
15	4.8	0.26	20.74	Pass
17	4.0	0.23	18.30	Pass
19	3.4	0.20	16.37	Pass
21	2.7	0.18	14.81	Pass
23	1.4	0.17	13.53	Pass
25	1.4	0.15	12.44	Pass
27	1.1	0.14	11.52	Pass
31	1.0	0.12	10.03	Pass
31	1.0	0.12	10.03	Pass
33	1.6	0.12	9.43	Pass
35	1.4	0.11	8.89	Pass
37	1.3	0.10	8.41	Pass
39	1.0	0.10	7.98	Pass

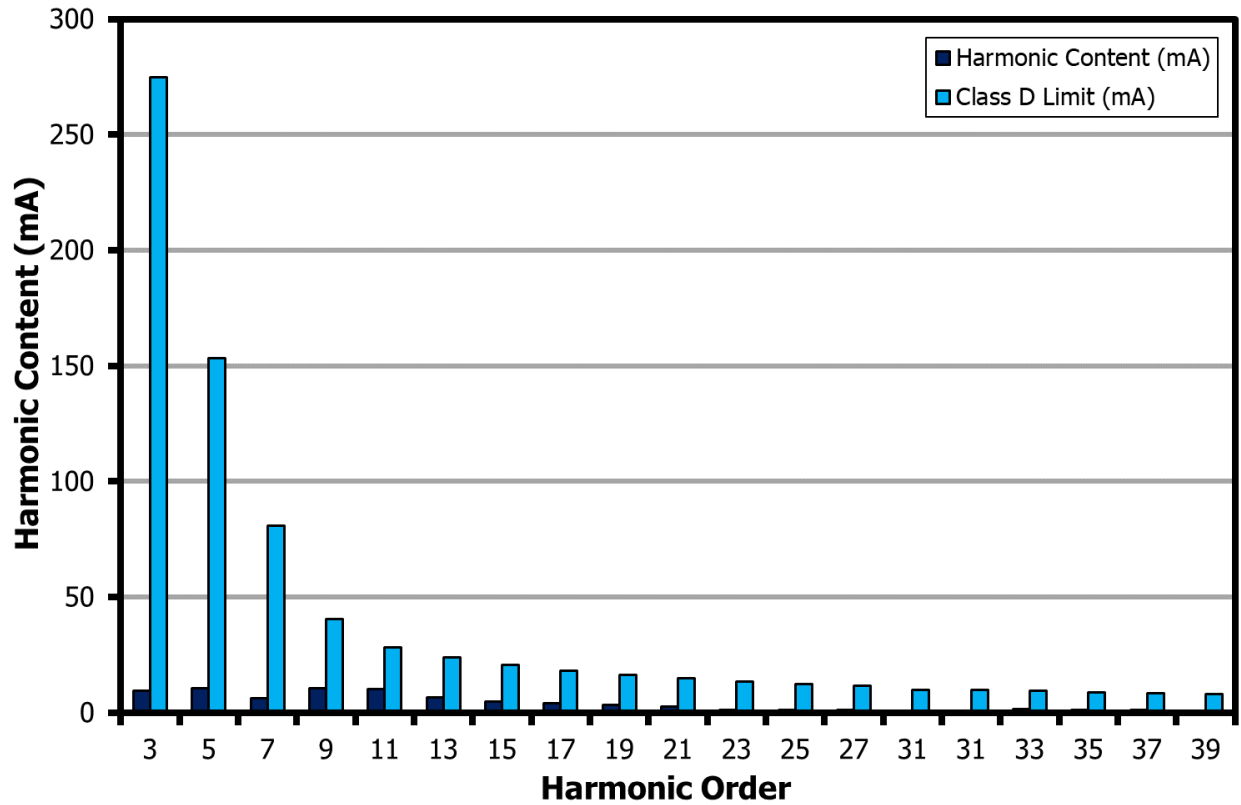

Figure 39 – Input Current Harmonics for 15 V Output, 5 A Load, 230 VAC, Room Temperature.

12.8.3 Output: 20 V / 5 A (115 VAC)

Input		Input Measurement					Output Measurement				
VAC _(RMS)	Freq (Hz)	V _{IN(RMS)}	I _{IN} (mA)	P _{IN} (W)	PF	% THD	V _{OUT} (V)	I _{OUT} (mA)	P _{OUT} (W)	%V Reg	Efficiency (%)
115	60	114.82	961.40	108.41	0.98	14.84	19.93	5000.80	99.64	0.37	91.91

Harmonic Order	Harmonic Content (mA)	Class D Limit (mA/W)	Class D Limit (mA)	Remarks
1	947.3			
3	122.1	3.40	368.70	Pass
5	57.8	1.90	206.04	Pass
7	23.6	1.00	108.44	Pass
9	7.8	0.50	54.22	Pass
11	2.0	0.35	37.95	Pass
13	7.0	0.30	32.11	Pass
15	8.2	0.26	27.83	Pass
17	9.8	0.23	24.56	Pass
19	10.6	0.20	21.97	Pass
21	10.1	0.18	19.88	Pass
23	8.4	0.17	18.15	Pass
25	8.1	0.15	16.70	Pass
27	9.1	0.14	15.46	Pass
31	6.7	0.12	13.47	Pass
31	6.7	0.12	13.47	Pass
33	4.1	0.12	12.65	Pass
35	3.2	0.11	11.93	Pass
37	3.4	0.10	11.28	Pass
39	2.8	0.10	10.70	Pass

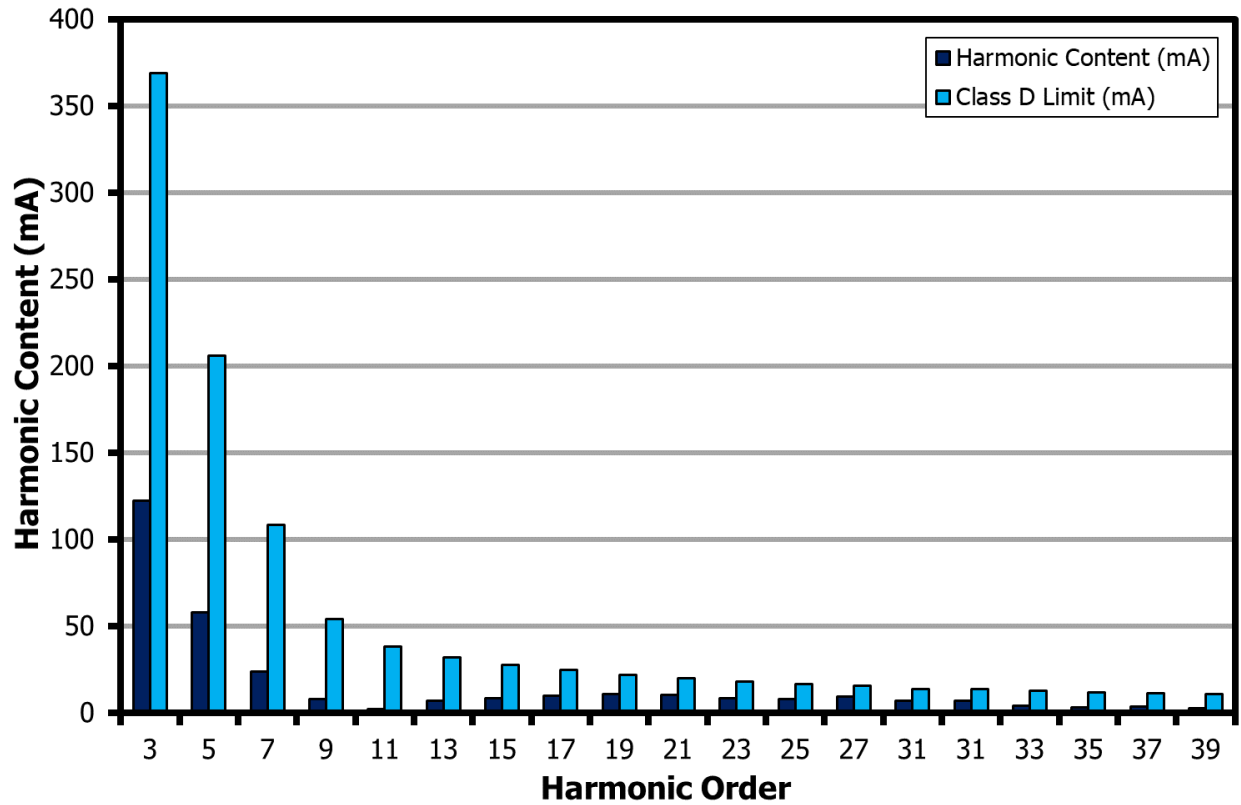

Figure 40 – Input Current Harmonics for 20 V Output, 5 A Load, 115 VAC, Room Temperature.

12.8.4 Output: 20 V / 5 A (230 VAC)

Input		Input Measurement					Output Measurement				
VAC _(RMS)	Freq (Hz)	V _{IN(RMS)}	I _{IN} (mA)	P _{IN} (W)	PF	% THD	V _{OUT} (V)	I _{OUT} (mA)	P _{OUT} (W)	%V Reg	Efficiency (%)
230	50	229.95	472.60	106.83	0.98	7.73	19.92	5001.00	99.64	0.38	93.27

Harmonic Order	Harmonic Content (mA)	Class D Limit (mA/W)	Class D Limit (mA)	Remarks
1	467.5			
3	30.6	3.40	363.22	Pass
5	14.8	1.90	202.98	Pass
7	4.8	1.00	106.83	Pass
9	0.2	0.50	53.42	Pass
11	1.5	0.35	37.39	Pass
13	1.4	0.30	31.64	Pass
15	1.3	0.26	27.42	Pass
17	2.7	0.23	24.19	Pass
19	1.2	0.20	21.65	Pass
21	2.5	0.18	19.59	Pass
23	1.3	0.17	17.88	Pass
25	2.2	0.15	16.45	Pass
27	2.0	0.14	15.23	Pass
31	3.1	0.12	13.27	Pass
31	3.1	0.12	13.27	Pass
33	0.8	0.12	12.46	Pass
35	2.4	0.11	11.75	Pass
37	1.5	0.10	11.12	Pass
39	1.3	0.10	10.55	Pass

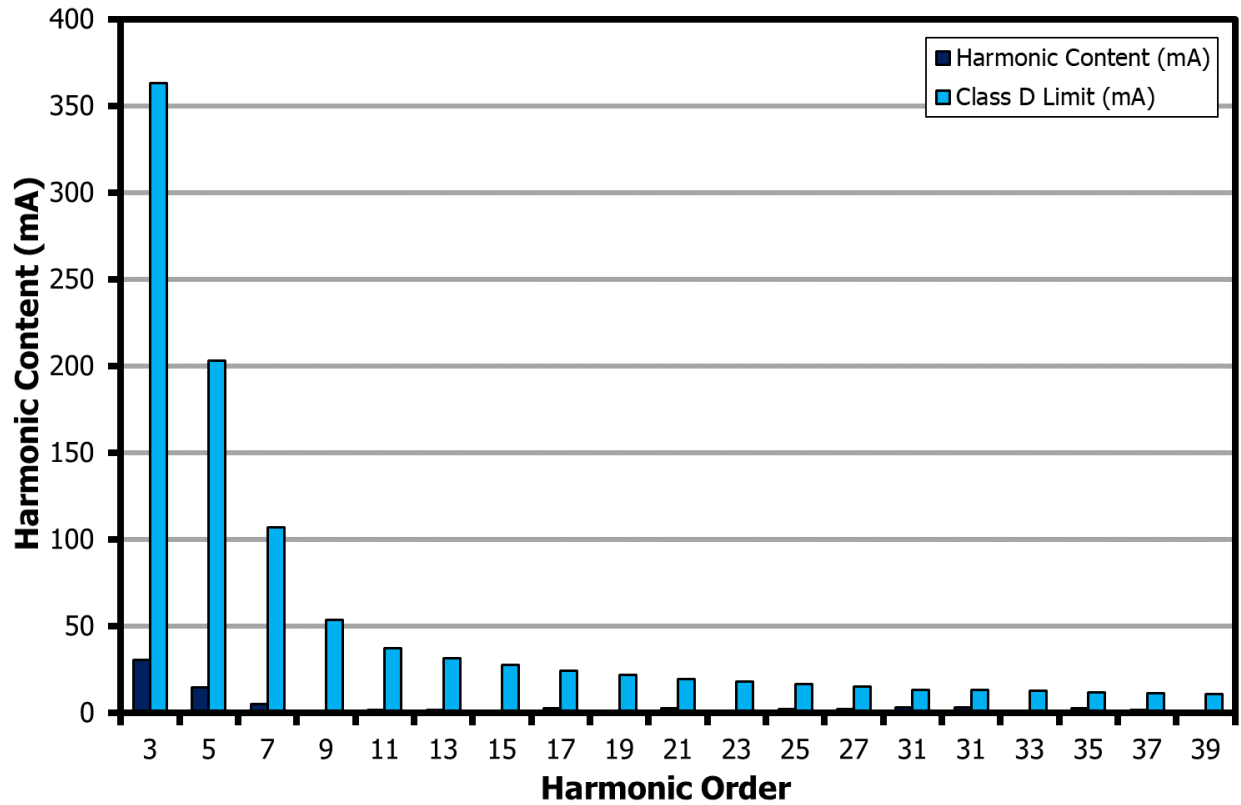

Figure 41 – Input Current Harmonics for 20 V Output, 5 A Load, 230 VAC, Room Temperature.

13 Thermal Performance

13.1 Thermal Performance in Open Case, Room Temperature

Note: 1. Open case thermal images are taken at room temperature ambient with the unit inside a closed acrylic box and 1-hour soak per condition.
2. For enclosed adapter application, this design requires use of metallic heat spreader and suitable thermally conductive insulator pads to ensure low temperature of the bridge rectifiers, HiperPFS-4, and InnoSwitch3-PD IC. The performance data below is for open case operation and does not use heat spreader for cooling.

13.1.1 Output: 5 V / 5 A (90 VAC)

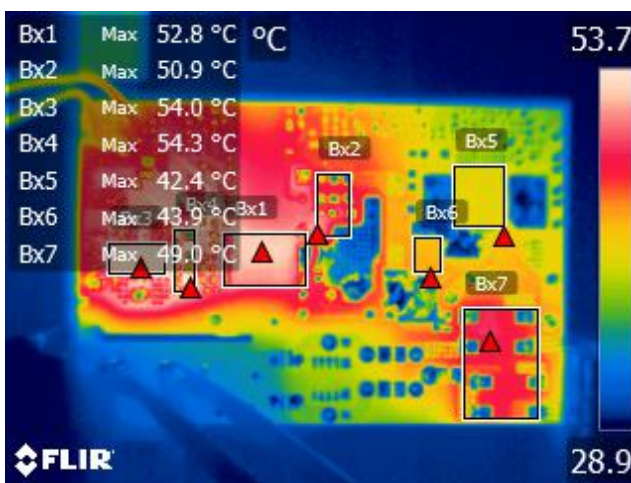

Figure 42 – Bottom Thermal Image, $T_{AMB} = 27.4$ °C.

Bx1: InnoSwitch3-PD = 52.8 °C.
Bx2: Primary Clamp = 50.9 °C.
Bx3: SR FET = 54.0 °C.
Bx4: SR FET Snubber = 54.3 °C.
Bx5: HiperPFS-4 = 42.4 °C.
Bx6: PFC Boost Diode = 43.9 °C.
Bx7: Bridge Rectifier = 49.0 °C.

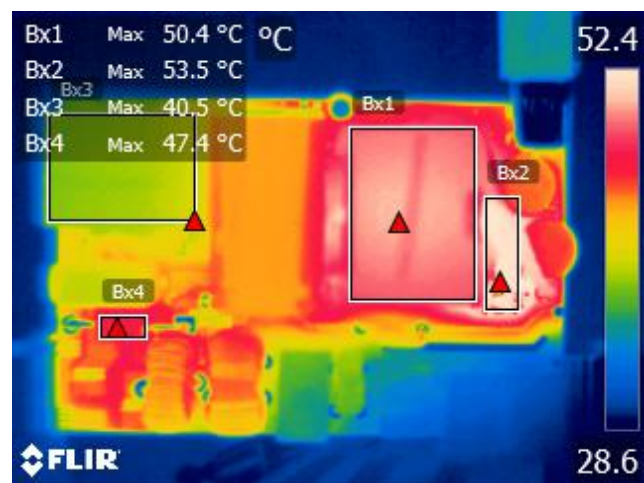

Figure 43 – Top Thermal Image, $T_{AMB} = 27.4$ °C.

Bx1: Transformer Core = 50.4 °C.
Bx2: Transformer Wire = 53.5 °C.
Bx3: PFC Inductor Core = 40.5 °C.
Bx4: Boost Pre-charge Diode = 47.4 °C.

13.1.2 Output: 5 V / 5 A (265 VAC)

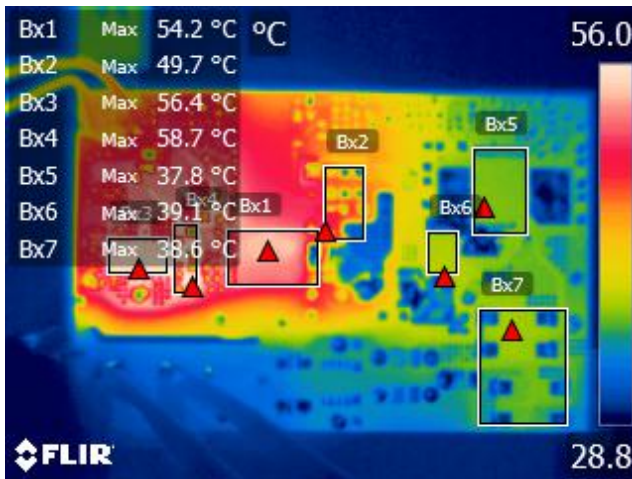

Figure 44 – Bottom Thermal Image, $T_{AMB} = 27.5$ °C.

Bx1: InnoSwitch3-PD = 54.2 °C.
 Bx2: Primary Clamp = 49.7 °C.
 Bx3: SR FET = 56.4 °C.
 Bx4: SR FET Snubber = 58.7 °C.
 Bx5: HiperPFS-4 = 37.8 °C.
 Bx6: PFC Boost Diode = 39.1 °C.
 Bx7: Bridge Rectifier = 38.6 °C.

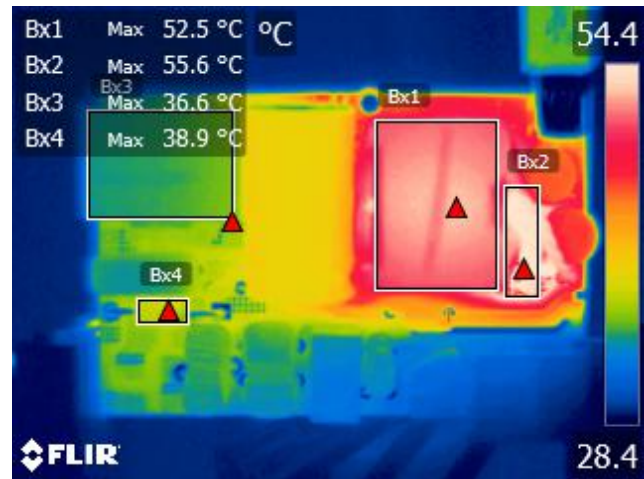

Figure 45 – Top Thermal Image, $T_{AMB} = 27.6$ °C.

Bx1: Transformer Core = 52.5 °C.
 Bx2: Transformer Wire = 55.6 °C.
 Bx3: PFC Inductor Core = 36.6 °C.
 Bx4: Boost Pre-charge Diode = 38.9 °C.

13.1.3 Output: 9 V / 5 A (90 VAC)

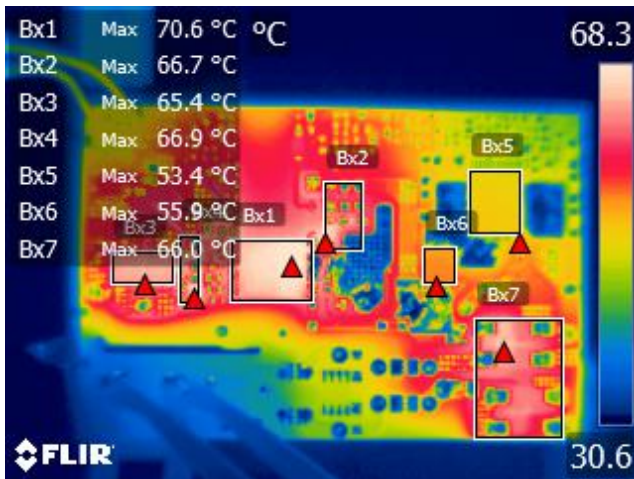

Figure 46 – Bottom Thermal Image, $T_{AMB} = 28.4$ °C.
 Bx1: InnoSwitch3-PD = 70.6 °C.
 Bx2: Primary Clamp = 66.7 °C.
 Bx3: SR FET = 65.4 °C.
 Bx4: SR FET Snubber = 66.9 °C.
 Bx5: HiperPFS-4 = 53.4 °C.
 Bx6: PFC Boost Diode = 55.9 °C.
 Bx7: Bridge Rectifier = 66.0 °C.



Figure 47 – Top Thermal Image, $T_{AMB} = 28.3$ °C.
 Bx1: Transformer Core = 62.8 °C.
 Bx2: Transformer Wire = 66.2 °C.
 Bx3: PFC Inductor Core = 50.2 °C.
 Bx4: Boost Pre-charge Diode = 62.9 °C.

13.1.4 Output: 9 V / 5 A (265 VAC)

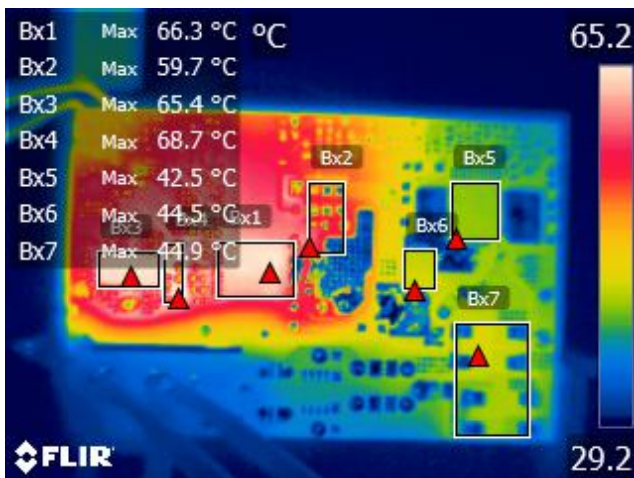

Figure 48 – Bottom Thermal Image, $T_{AMB} = 27.8$ °C.
 Bx1: InnoSwitch3-PD = 66.3 °C.
 Bx2: Primary Clamp = 59.7 °C.
 Bx3: SR FET = 65.4 °C.
 Bx4: SR FET Snubber = 68.7 °C.
 Bx5: HiperPFS-4 = 42.5 °C.
 Bx6: PFC Boost Diode = 44.5 °C.
 Bx7: Bridge Rectifier = 44.9 °C.

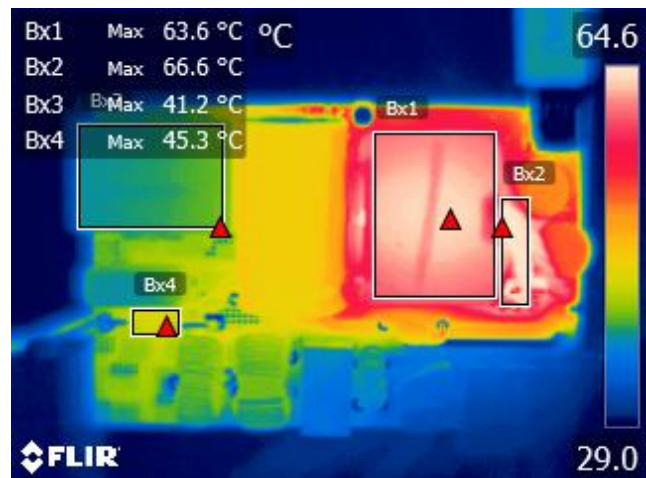

Figure 49 – Top Thermal Image, $T_{AMB} = 27.8$ °C.
 Bx1: Transformer Core = 63.6 °C.
 Bx2: Transformer Wire = 66.6 °C.
 Bx3: PFC Inductor Core = 41.2 °C.
 Bx4: Boost Pre-charge Diode = 45.3 °C.

13.1.5 Output: 12 V / 5 A (90 VAC)

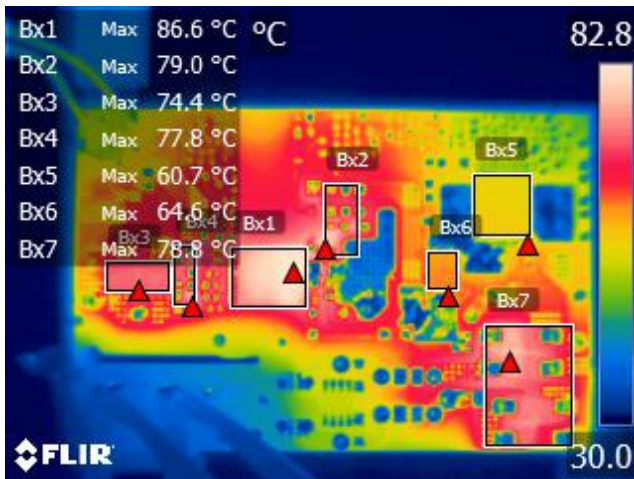

Figure 50 – Bottom Thermal Image, $T_{AMB} = 28.2\text{ °C}$.
 Bx1: InnoSwitch3-PD = 86.6 °C.
 Bx2: Primary Clamp = 79.0 °C.
 Bx3: SR FET = 74.4 °C.
 Bx4: SR FET Snubber = 77.8 °C.
 Bx5: HiperPFS-4 = 60.7 °C.
 Bx6: PFC Boost Diode = 64.6 °C.
 Bx7: Bridge Rectifier = 78.8 °C.



Figure 51 – Top Thermal Image, $T_{AMB} = 28.2\text{ °C}$.
 Bx1: Transformer Core = 70.8 °C.
 Bx2: Transformer Wire = 74.8 °C.
 Bx3: PFC Inductor Core = 57.0 °C.
 Bx4: Boost Pre-charge Diode = 74.2 °C.

13.1.6 Output: 12 V / 5 A (265 VAC)

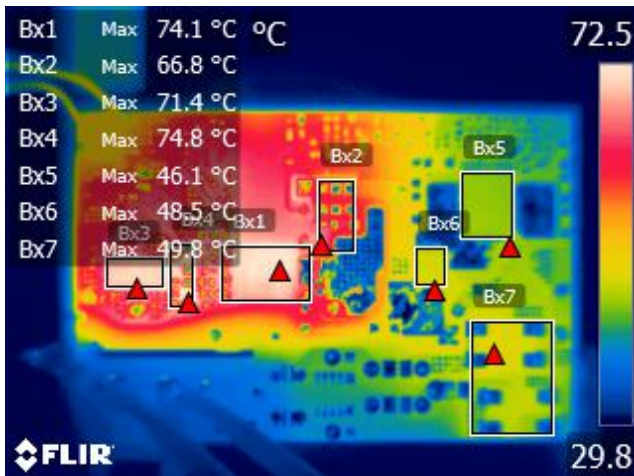

Figure 52 – Bottom Thermal Image, $T_{AMB} = 28.2\text{ °C}$.
 Bx1: InnoSwitch3-PD = 74.1 °C.
 Bx2: Primary Clamp = 66.8 °C.
 Bx3: SR FET = 71.4 °C.
 Bx4: SR FET Snubber = 74.8 °C.
 Bx5: HiperPFS-4 = 46.1 °C.
 Bx6: PFC Boost Diode = 48.5 °C.
 Bx7: Bridge Rectifier = 49.8 °C.



Figure 53 – Top Thermal Image, $T_{AMB} = 28.2\text{ °C}$.
 Bx1: Transformer Core = 72.1 °C.
 Bx2: Transformer Wire = 74.4 °C.
 Bx3: PFC Inductor Core = 45.6 °C.
 Bx4: Boost Pre-charge Diode = 51.1 °C.

13.1.7 Output: 15 V / 5 A (90 VAC)

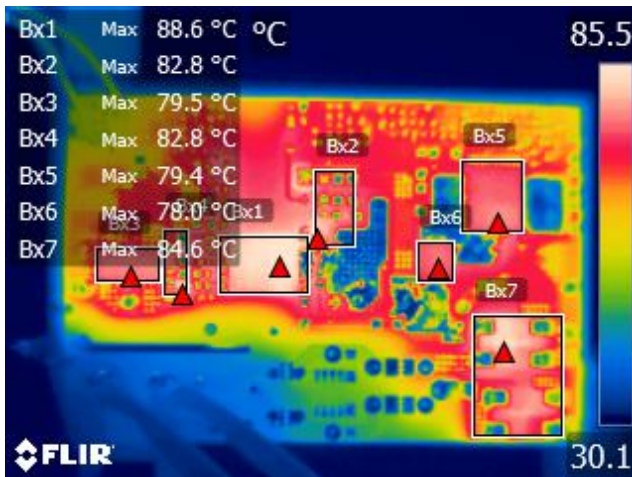

Figure 54 – Bottom Thermal Image, $T_{AMB} = 28.0$ °C.
 Bx1: InnoSwitch3-PD = 88.6 °C.
 Bx2: Primary Clamp = 82.8 °C.
 Bx3: SR FET = 79.5 °C.
 Bx4: SR FET Snubber = 82.8 °C.
 Bx5: HiperPFS-4 = 79.4 °C.
 Bx6: PFC Boost Diode = 78.0 °C.
 Bx7: Bridge Rectifier = 84.6 °C.

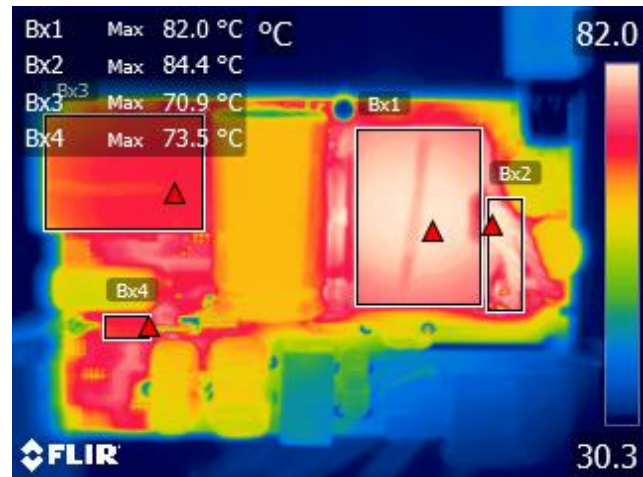

Figure 55 – Top Thermal Image, $T_{AMB} = 28.3$ °C.
 Bx1: Transformer Core = 82.0 °C.
 Bx2: Transformer Wire = 84.4 °C.
 Bx3: PFC Inductor Core = 70.9 °C.
 Bx4: Boost Pre-charge Diode = 73.5 °C.

13.1.8 Output: 15 V / 5 A (265 VAC)

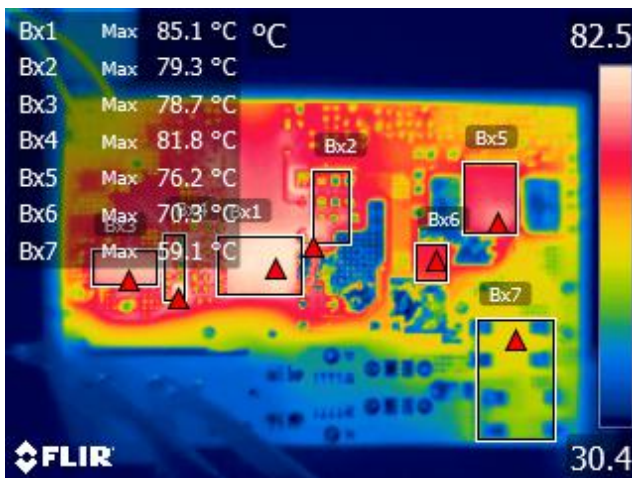

Figure 56 – Bottom Thermal Image, $T_{AMB} = 28.9$ °C.
 Bx1: InnoSwitch3-PD = 85.1 °C.
 Bx2: Primary Clamp = 79.3 °C.
 Bx3: SR FET = 78.7 °C.
 Bx4: SR FET Snubber = 81.8 °C.
 Bx5: HiperPFS-4 = 76.2 °C.
 Bx6: PFC Boost Diode = 70.3 °C.
 Bx7: Bridge Rectifier = 59.1 °C.

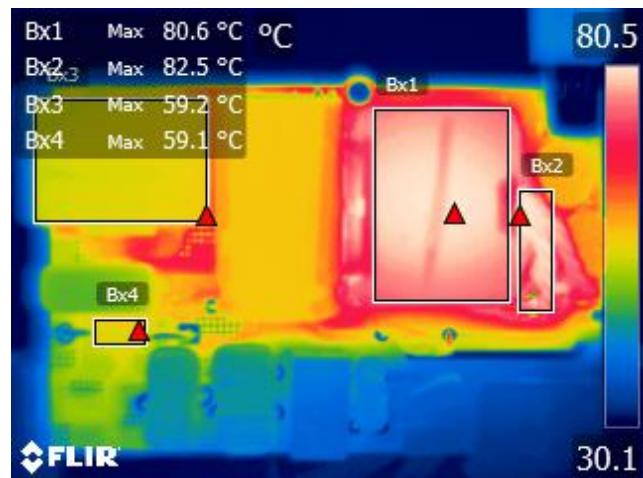

Figure 57 – Top Thermal Image, $T_{AMB} = 28.8$ °C.
 Bx1: Transformer Core = 80.6 °C.
 Bx2: Transformer Wire = 82.5 °C.
 Bx3: PFC Inductor Core = 59.2 °C.
 Bx4: Boost Pre-charge Diode = 59.1 °C.

13.1.9 Output: 20 V / 5 A (90 VAC)

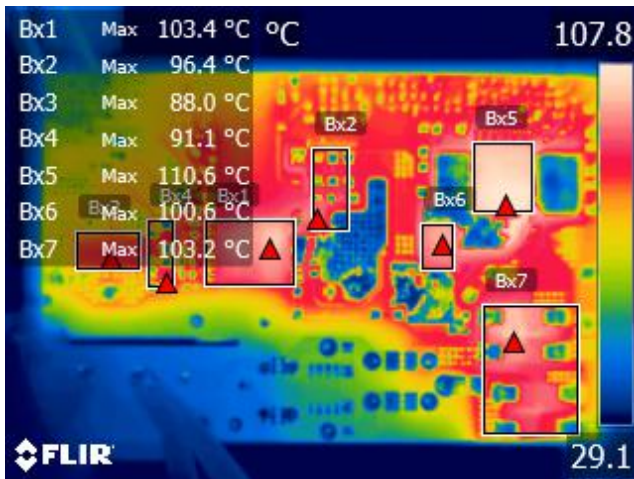

Figure 58 – Bottom Thermal Image, $T_{AMB} = 27.9$ °C.
 Bx1: InnoSwitch3-PD = 103.4 °C.
 Bx2: Primary Clamp = 96.4 °C.
 Bx3: SR FET = 88.0 °C.
 Bx4: SR FET Snubber = 91.1 °C.
 Bx5: HiperPFS-4 = 110.6 °C.
 Bx6: PFC Boost Diode = 100.6 °C.
 Bx7: Bridge Rectifier = 103.2 °C.



Figure 59 – Top Thermal Image, $T_{AMB} = 27.9$ °C.
 Bx1: Transformer Core = 94.3 °C.
 Bx2: Transformer Wire = 95.4 °C.
 Bx3: PFC Inductor Core = 88.5 °C.
 Bx4: Boost Pre-charge Diode = 88.2 °C.

13.1.10 Output: 20 V / 5 A (265 VAC)

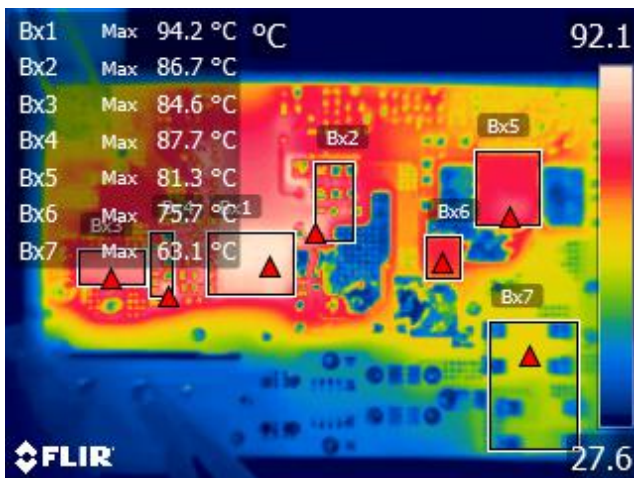

Figure 60 – Bottom Thermal Image, $T_{AMB} = 27.5$ °C.
 Bx1: InnoSwitch3-PD = 94.2 °C.
 Bx2: Primary Clamp = 86.7 °C.
 Bx3: SR FET = 84.6 °C.
 Bx4: SR FET Snubber = 87.7 °C.
 Bx5: HiperPFS-4 = 81.3 °C.
 Bx6: PFC Boost Diode = 75.7 °C.
 Bx7: Bridge Rectifier = 63.1 °C.

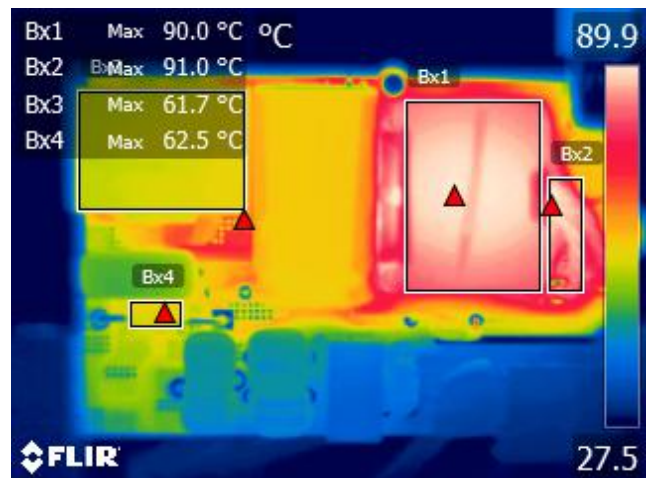

Figure 61 – Top Thermal Image, $T_{AMB} = 27.4$ °C.
 Bx1: Transformer Core = 90.0 °C.
 Bx2: Transformer Wire = 91.0 °C.
 Bx3: PFC Inductor Core = 61.7 °C.
 Bx4: Boost Pre-charge Diode = 62.5 °C.

14 Waveforms

Note: 1. Output voltage captured at the end of 100 mΩ cable unless otherwise specified.
 2. Waveforms taken at room temperature ambient (approximately 25 °C).

14.1 Input Voltage and Current Waveforms

14.1.1 Output: 15 V / 5 A

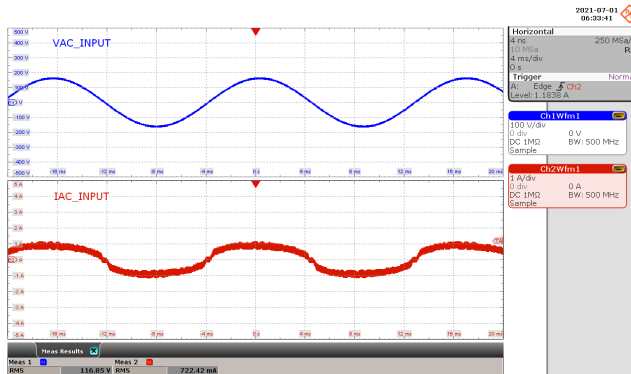

Figure 62 – Input Voltage and Current.
 115 VAC, 15.0 V, 5 A Load.
 CH1: V_{IN_AC} , 100 V / div.
 CH2: I_{IN_AC} , 1 A / div.
 Time: 4 ms / div.

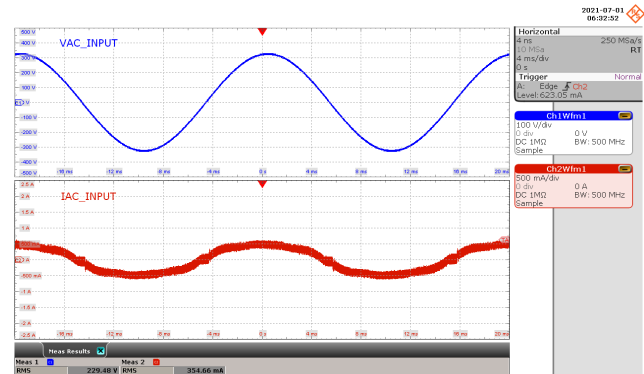

Figure 63 – Input Drain Voltage and Current.
 230 VAC, 15.0 V, 5 A Load.
 CH1: V_{IN_AC} , 100 V / div.
 CH2: I_{IN_AC} , 1 A / div.
 Time: 4 ms / div.

14.1.2 Output: 20 V / 5 A

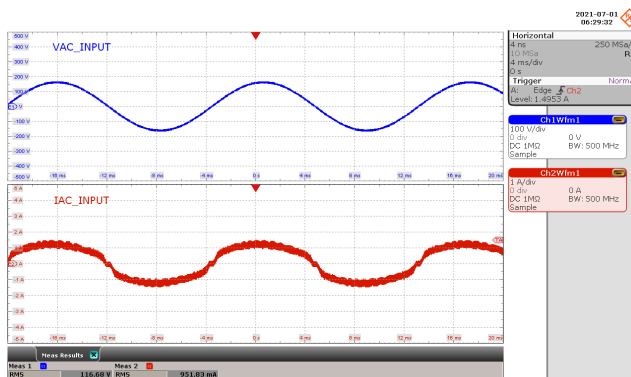

Figure 64 – Input Drain Voltage and Current.
 90 VAC, 20.0 V, 5 A Load.
 CH1: V_{IN_AC} , 100 V / div.
 CH2: I_{IN_AC} , 1 A / div.
 Time: 4 ms / div.

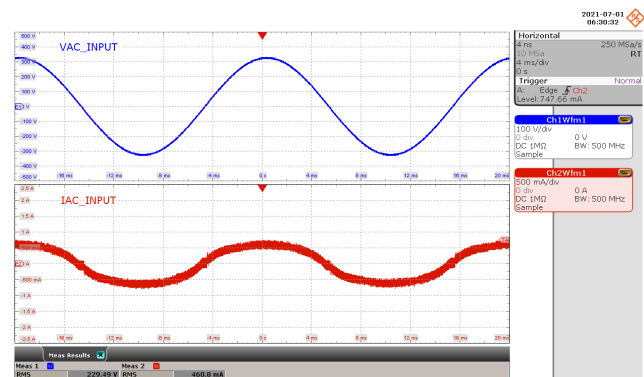

Figure 65 – Input Drain Voltage and Current.
 265 VAC, 20.0 V, 5 A Load.
 CH1: V_{IN_AC} , 100 V / div.
 CH2: I_{IN_AC} , 1 A / div.
 Time: 4 ms / div.

14.2 PFC Inductor Current and HiperPFS-4 Drain Voltage Waveforms

14.2.1 Output: 15 V / 5 A

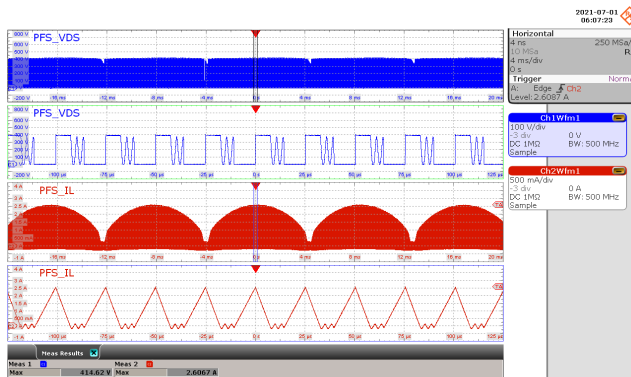

Figure 66 – PFC Inductor Current and HiperPFS-4 Drain Voltage.
 115 VAC, 15.0 V, 5 A Load.
 $V_{DS_PFS} = 414$ V Maximum.
 $I_{L_PFC} = 2.60$ A Maximum.
 CH1: V_{DS_PFS} , 100 V / div.
 CH2: I_{L_PFC} , 500 mA / div.
 Time: 4 ms / div. (25 μ s / div. Zoom).

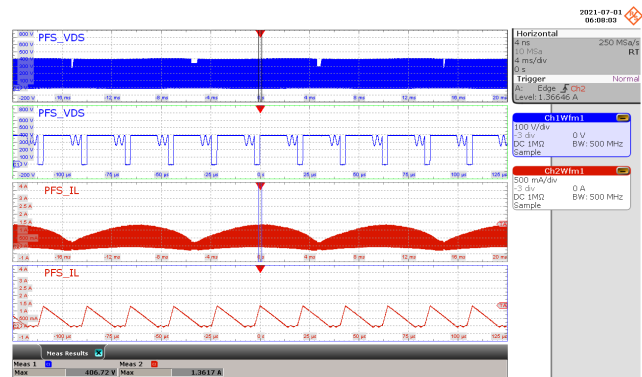

Figure 67 – PFC Inductor Current and HiperPFS-4 Drain Voltage.
 230 VAC, 15.0 V, 5 A Load.
 $V_{DS_PFS} = 406$ V Maximum.
 $I_{L_PFC} = 1.36$ A Maximum.
 CH1: V_{DS_PFS} , 100 V / div.
 CH2: I_{L_PFC} , 500 mA / div.
 Time: 4 ms / div. (25 μ s / div. Zoom).

14.2.2 Output: 20 V / 5 A

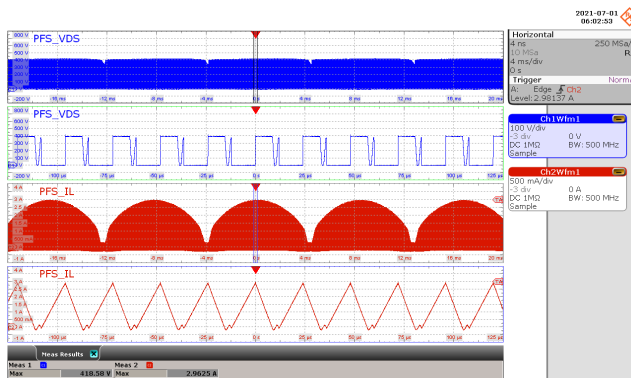

Figure 68 – PFC Inductor Current and HiperPFS-4 Drain Voltage.
 115 VAC, 20.0 V, 5 A Load.
 $V_{DS_PFS} = 418$ V Maximum.
 $I_{L_PFC} = 2.96$ A Maximum.
 CH1: V_{DS_PFS} , 100 V / div.
 CH2: I_{L_PFC} , 500 mA / div.
 Time: 4 ms / div. (25 μ s / div. Zoom).

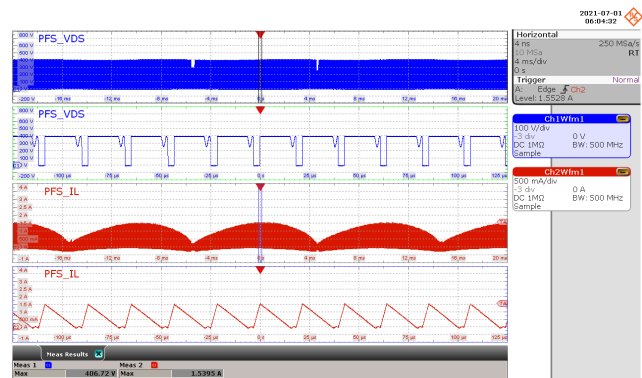

Figure 69 – PFC Inductor Current and HiperPFS-4 Drain Voltage.
 230 VAC, 20.0 V, 5 A Load.
 $V_{DS_PFS} = 406$ V Maximum.
 $I_{L_PFC} = 1.539$ A Maximum.
 CH1: V_{DS_PFS} , 100 V / div.
 CH2: I_{L_PFC} , 500 mA / div.
 Time: 4 ms / div. (25 μ s / div. Zoom).

14.3 Start-up Waveforms

14.3.1 Output Voltage and Current

Output voltage at the end of 100 mΩ cable and load current were captured.



Figure 70 – Output Voltage and Current.
 90 VAC, 5.0 V, 5 A (CR Mode,
 880 mΩ at the End of 100 mΩ Cable).
 $V_{OUT} = 4.4625$ V Steady-State.
 CH1: V_{OUT} , 1 V / div.
 CH2: I_{LOAD} , 1 A / div.
 Time: 40 ms / div.

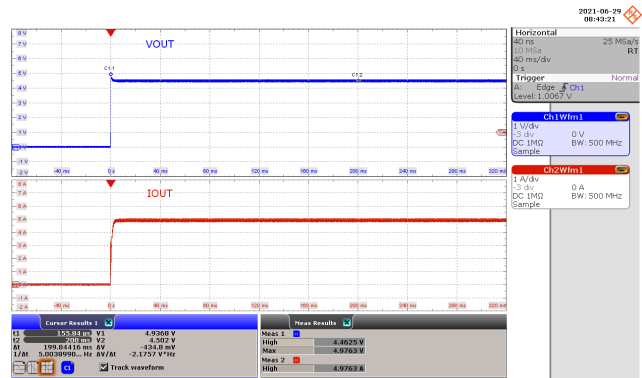

Figure 71 – Output Voltage and Current.
 265 VAC, 5.0 V, 5 A (CR Mode,
 880 mΩ at the End of 100 mΩ Cable).
 $V_{OUT} = 4.4625$ V Steady-State.
 CH1: V_{OUT} , 1 V / div.
 CH2: I_{LOAD} , 1 A / div.
 Time: 40 ms / div.

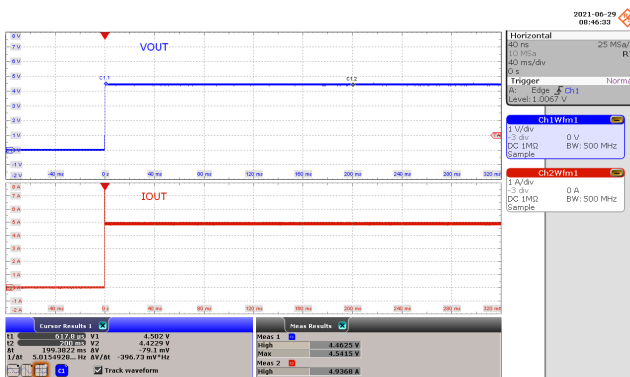

Figure 72 – Output Voltage and Current.
 90 VAC, 5.0 V, 5 A (CC Mode).
 $V_{OUT} = 4.4625$ V Steady-State.
 CH1: V_{OUT} , 1 V / div.
 CH2: I_{LOAD} , 1 A / div.
 Time: 40 ms / div.

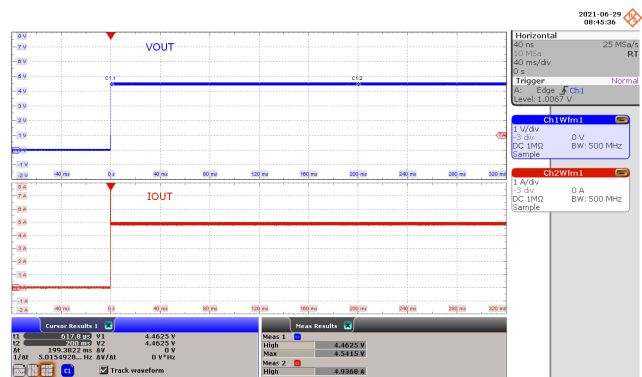

Figure 73 – Output Voltage and Current.
 265 VAC, 5.0 V, 5 A (CC Mode).
 $V_{OUT} = 4.4625$ V Steady-State.
 CH1: V_{OUT} , 1 V / div.
 CH2: I_{LOAD} , 1 A / div.
 Time: 40 ms / div.

14.3.2 Primary Drain Voltage and Current

Primary Drain Voltage, Drain Current, and output voltage before the bus switch were captured.

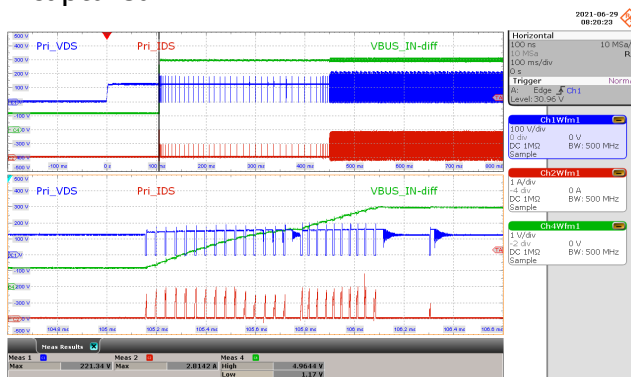

Figure 74 – Primary Drain Voltage and Current. 90 VAC, 5.0 V, 5 A (CR Mode, 880 mΩ at the End of 100 mΩ Cable). $V_{DS_PRI} = 221$ V Maximum. CH1: V_{DS_PRI} , 100 V / div. CH2: I_{DS_PRI} , 1 A / div. CH4: V_{BUS_IN} , 1 V / div. Time: 100 ms / div. (200 μs / div. Zoom).

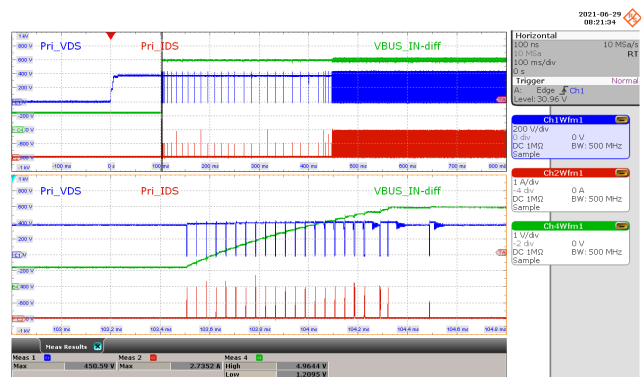

Figure 75 – Primary Drain Voltage and Current. 265 VAC, 5.0 V, 5 A (CR Mode, 880 mΩ at the End of 100 mΩ Cable). $V_{DS_PRI} = 450$ V Maximum. CH1: V_{DS_PRI} , 200 V / div. CH2: I_{DS_PRI} , 1 A / div. CH4: V_{BUS_IN} , 1 V / div. Time: 100 ms / div. (200 μs / div. Zoom).

14.3.3 SR FET Drain Voltage and Current

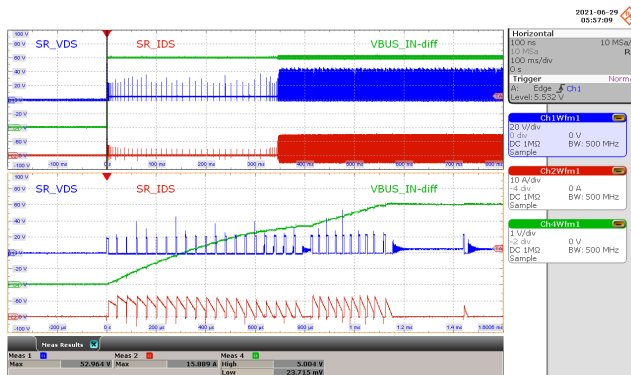

Figure 76 – SR FET Drain Voltage and Current. 90 VAC, 5.0 V, 5 A (CR Mode, 930 mΩ at the End of 100 mΩ Cable). $V_{DS_SRFET} = 52.9$ V Maximum. CH1: V_{DS_SRFET} , 20 V / div. CH2: I_{DS_SRFET} , 10 A / div. CH4: V_{BUS_IN} , 1 V / div. Time: 100 ms / div. (200 μs / div. Zoom).

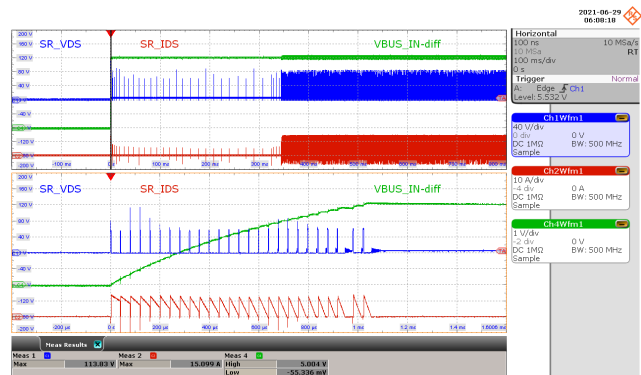

Figure 77 – SR FET Drain Voltage and Current. 265 VAC, 5.0 V, 5 A (CR Mode, 930 mΩ at the End of 100 mΩ Cable). $V_{DS_SRFET} = 113.8$ V Maximum. CH1: V_{DS_SRFET} , 40 V / div. CH2: I_{DS_SRFET} , 10 A / div. CH4: V_{BUS_IN} , 1 V / div. Time: 100 ms / div. (200 μs / div. Zoom).

14.4 Primary Drain Voltage and Current (Steady-State)

14.4.1 Output: 5 V / 5 A

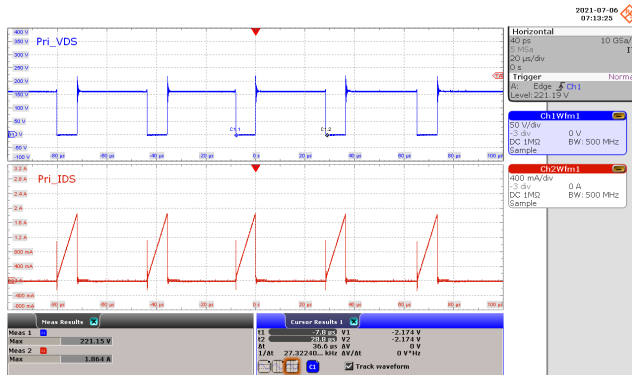

Figure 78 – Primary Drain Voltage and Current.
 90 VAC, 5.0 V, 5 A Load.
 $V_{DS_PRI} = 221\text{ V}$ Maximum.
 CH1: V_{DS_PRI} , 50 V / div.
 CH2: I_{DS_PRI} , 400 mA / div.
 Time: 20 μs / div.

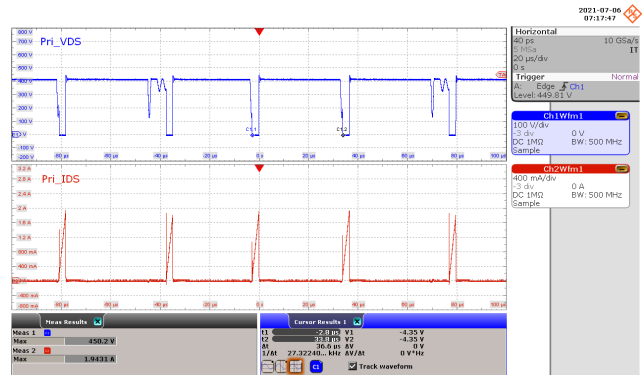

Figure 79 – Primary Drain Voltage and Current.
 265 VAC, 5.0 V, 5 A Load.
 $V_{DS_PRI} = 450\text{ V}$ Maximum.
 CH1: V_{DS_PRI} , 100 V / div.
 CH2: I_{DS_PRI} , 400 mA / div.
 Time: 20 μs / div.

14.4.2 Output: 9 V / 5 A

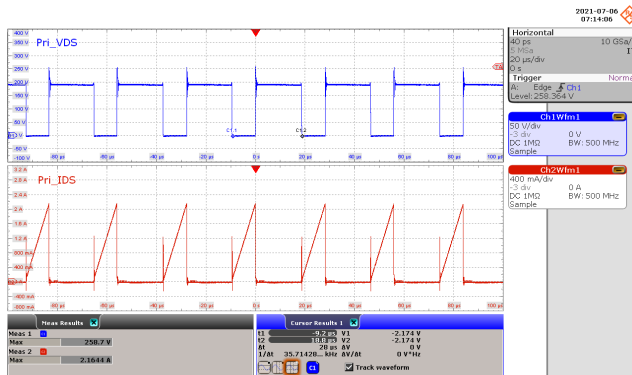

Figure 80 – Primary Drain Voltage and Current.
 90 VAC, 9.0 V, 5 A Load.
 $V_{DS_PRI} = 258\text{ V}$ Maximum.
 CH1: V_{DS_PRI} , 50 V / div.
 CH2: I_{DS_PRI} , 400 mA / div.
 Time: 20 μs / div.

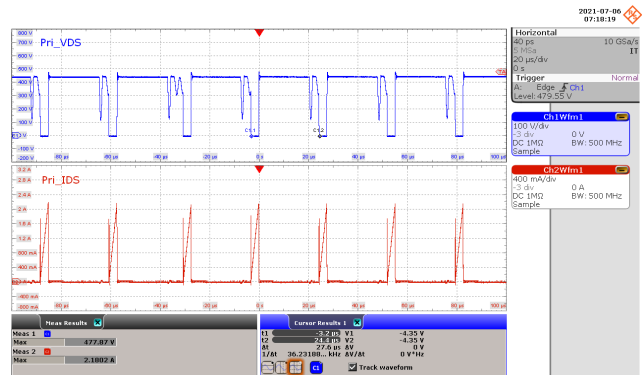

Figure 81 – Primary Drain Voltage and Current.
 265 VAC, 9.0 V, 5 A Load.
 $V_{DS_PRI} = 477\text{ V}$ Maximum.
 CH1: V_{DS_PRI} , 100 V / div.
 CH2: I_{DS_PRI} , 400 mA / div.
 Time: 20 μs / div.

14.4.3 Output: 12 V / 5 A

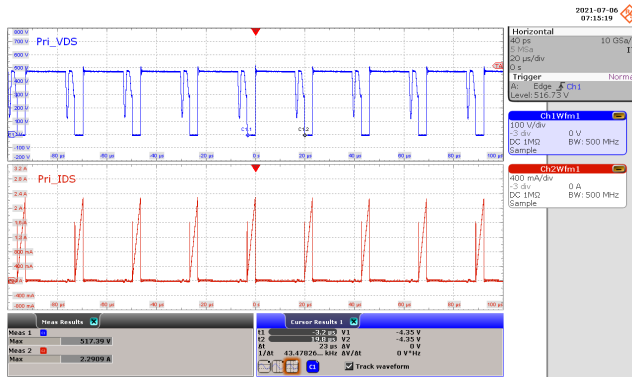

Figure 82 – Primary Drain Voltage and Current.
 90 VAC, 12.0 V, 5 A Load.
 $V_{DS_PRI} = 517$ V Maximum.
 CH1: V_{DS_PRI} , 100 V / div.
 CH2: I_{DS_PRI} , 400 mA / div.
 Time: 20 μ s / div.

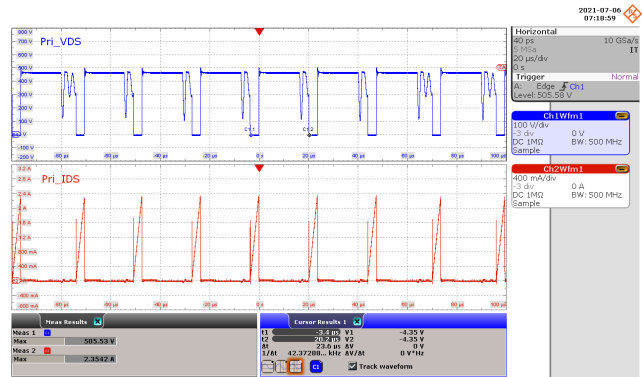

Figure 83 – Primary Drain Voltage and Current.
 265 VAC, 12.0 V, 5 A Load.
 $V_{DS_PRI} = 505$ V Maximum.
 CH1: V_{DS_PRI} , 100 V / div.
 CH2: I_{DS_PRI} , 400 mA / div.
 Time: 20 μ s / div.

14.4.4 Output: 15 V / 5 A

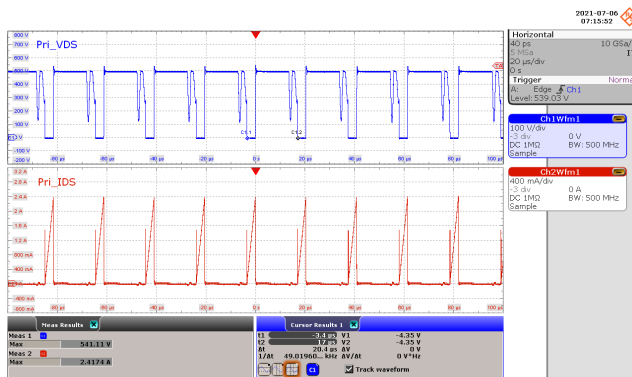

Figure 84 – Primary Drain Voltage and Current.
 90 VAC, 15.0 V, 5 A Load.
 $V_{DS_PRI} = 511$ V Maximum.
 CH1: V_{DS_PRI} , 100 V / div.
 CH2: I_{DS_PRI} , 400 mA / div.
 Time: 20 μ s / div.

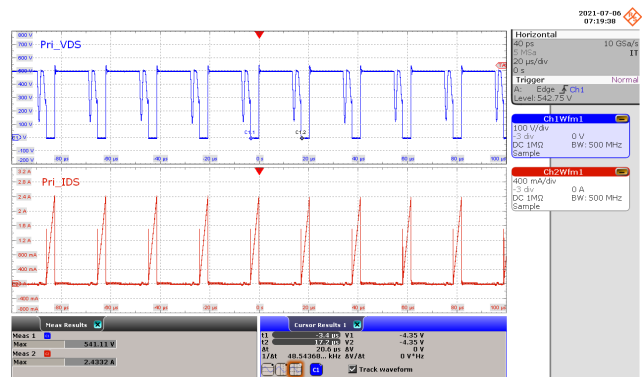

Figure 85 – Primary Drain Voltage and Current.
 265 VAC, 15.0 V, 5 A Load.
 $V_{DS_PRI} = 541$ V Maximum.
 CH1: V_{DS_PRI} , 100 V / div.
 CH2: I_{DS_PRI} , 400 mA / div.
 Time: 20 μ s / div.

14.4.5 Output: 20 V / 5 A

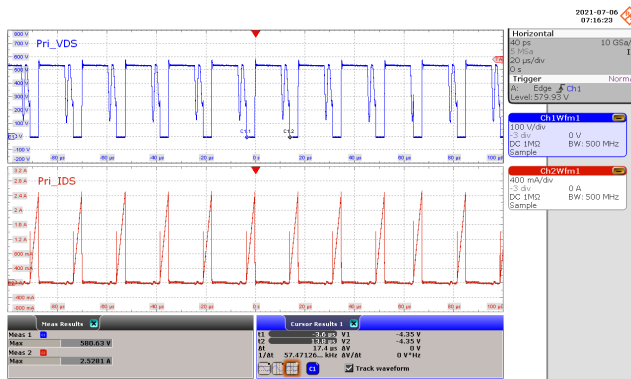

Figure 86 – Primary Drain Voltage and Current.
 90 VAC, 20.0 V, 5 A Load.
 $V_{DS_PRI} = 580\text{ V}$ Maximum.
 CH1: V_{DS_PRI} , 100 V / div.
 CH2: I_{DS_PRI} , 400 mA / div.
 Time: 20 μs / div.

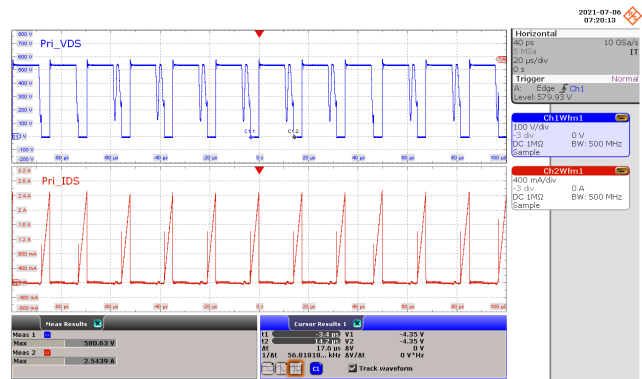

Figure 87 – Primary Drain Voltage and Current.
 265 VAC, 20.0 V, 5 A Load.
 $V_{DS_PRI} = 580\text{ V}$ Maximum.
 CH1: V_{DS_PRI} , 100 V / div.
 CH2: I_{DS_PRI} , 400 mA / div.
 Time: 20 μs / div.

14.5 SR FET Drain Voltage and Current (Steady-State)

14.5.1 Output: 5 V / 5 A

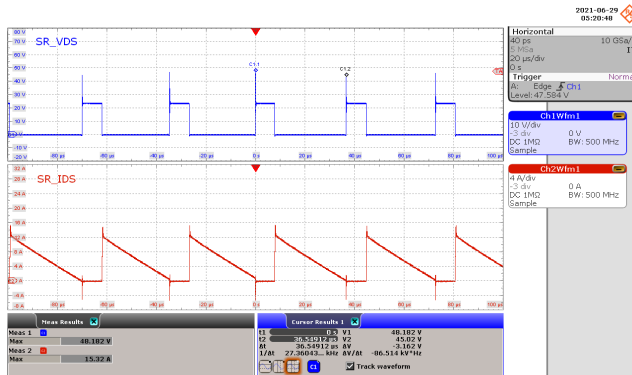

Figure 88 – SR FET Drain Voltage and Current.
 90 VAC, 5.0 V, 5 A Load.
 $V_{DS_SRFET} = 48.1 \text{ V}$ Maximum.
 CH1: V_{DS_SRFET} , 10 V / div.
 CH2: I_{DS_SRFET} , 4 A / div.
 Time: 20 μs / div.

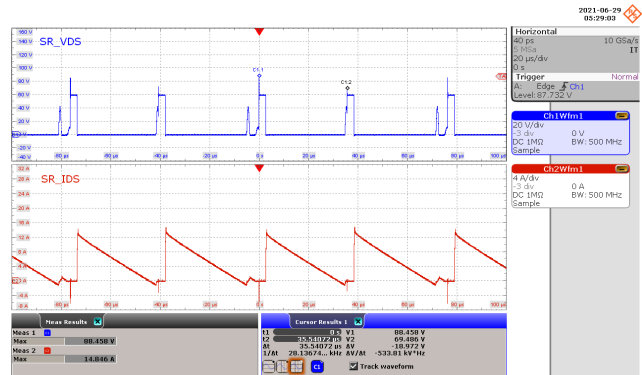

Figure 89 – SR FET Drain Voltage and Current.
 265 VAC, 5.0 V, 5 A Load.
 $V_{DS_SRFET} = 88.4 \text{ V}$ Maximum.
 CH1: V_{DS_SRFET} , 20 V / div.
 CH2: I_{DS_SRFET} , 4 A / div.
 Time: 20 μs / div.

14.5.2 Output: 9 V / 5 A

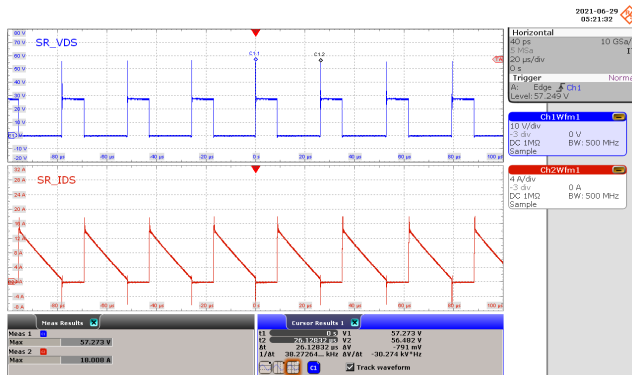

Figure 90 – SR FET Drain Voltage and Current.
 90 VAC, 9.0 V, 5 A Load.
 $V_{DS_SRFET} = 57.2 \text{ V}$ Maximum.
 CH1: V_{DS_SRFET} , 10 V / div.
 CH2: I_{DS_SRFET} , 4 A / div.
 Time: 20 μs / div.

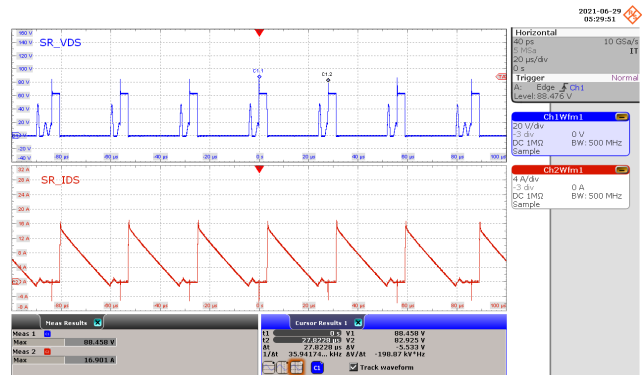

Figure 91 – SR FET Drain Voltage and Current.
 265 VAC, 9.0 V, 5 A Load.
 $V_{DS_SRFET} = 88.4 \text{ V}$ Maximum.
 CH1: V_{DS_SRFET} , 20 V / div.
 CH2: I_{DS_SRFET} , 4 A / div.
 Time: 20 μs / div.

14.5.3 Output: 12 V / 5 A

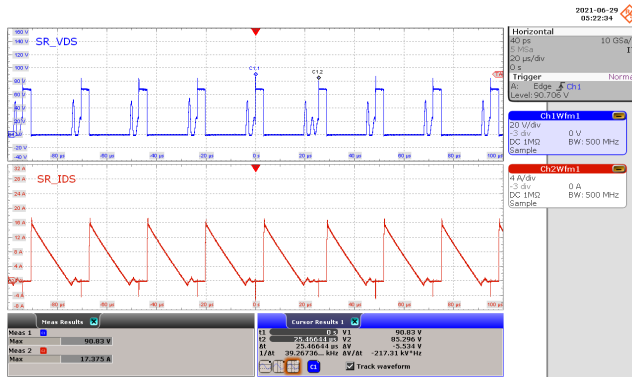

Figure 92 – SR FET Drain Voltage and Current.
 90 VAC, 12.0 V, 5 A Load.
 $V_{DS_SRFET} = 90.8 \text{ V}$ Maximum.
 CH1: V_{DS_SRFET} , 20 V / div.
 CH2: I_{DS_SRFET} , 4 A / div.
 Time: 20 μs / div.

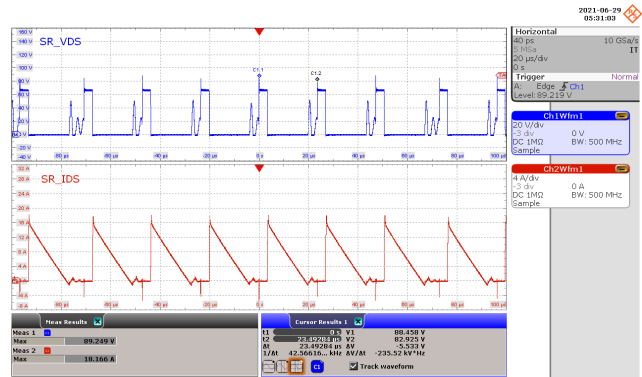

Figure 93 – SR FET Drain Voltage and Current.
 265 VAC, 12.0 V, 5 A Load.
 $V_{DS_SRFET} = 89.2 \text{ V}$ Maximum.
 CH1: V_{DS_SRFET} , 20 V / div.
 CH2: I_{DS_SRFET} , 4 A / div.
 Time: 20 μs / div.

14.5.4 Output: 15 V / 5 A

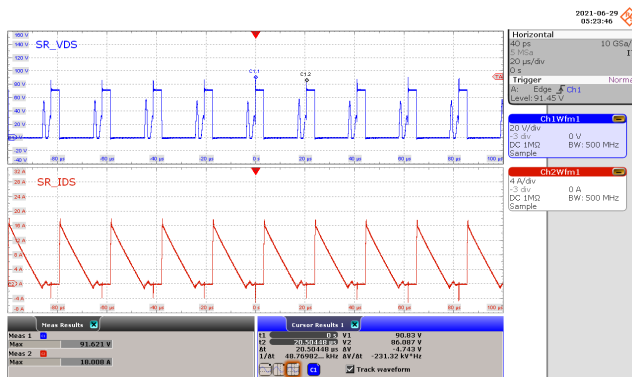

Figure 94 – SR FET Drain Voltage and Current.
 90 VAC, 15.0 V, 5 A Load.
 $V_{DS_SRFET} = 91.6 \text{ V}$ Maximum.
 CH1: V_{DS_SRFET} , 20 V / div.
 CH2: I_{DS_SRFET} , 4 A / div.
 Time: 20 μs / div.

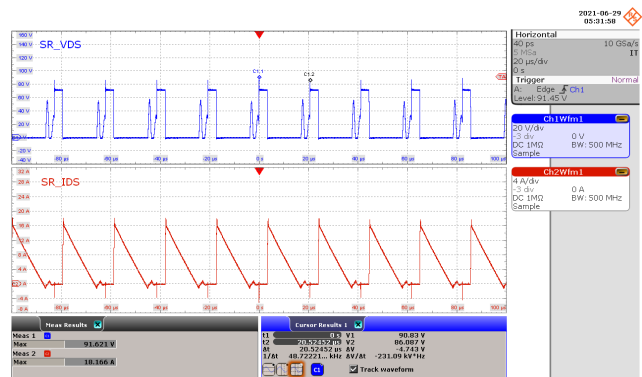

Figure 95 – SR FET Drain Voltage and Current.
 265 VAC, 15 V, 5 A Load.
 $V_{DS_SRFET} = 91.6 \text{ V}$ Maximum.
 CH1: V_{DS_SRFET} , 20 V / div.
 CH2: I_{DS_SRFET} , 4 A / div.
 Time: 20 μs / div.

14.5.5 Output: 20 V / 5 A

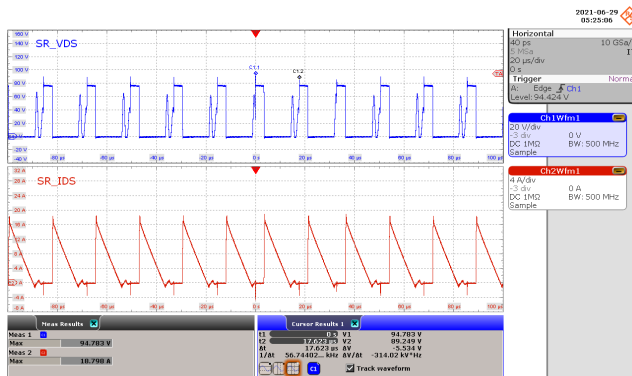

Figure 96 – SR FET Drain Voltage and Current.
 90 VAC, 20.0 V, 5 A Load.
 $V_{DS_SRFET} = 94.7$ V Maximum.
 CH1: V_{DS_SRFET} , 20 V / div.
 CH2: I_{DS_SRFET} , 4 A / div.
 Time: 20 μ s / div.

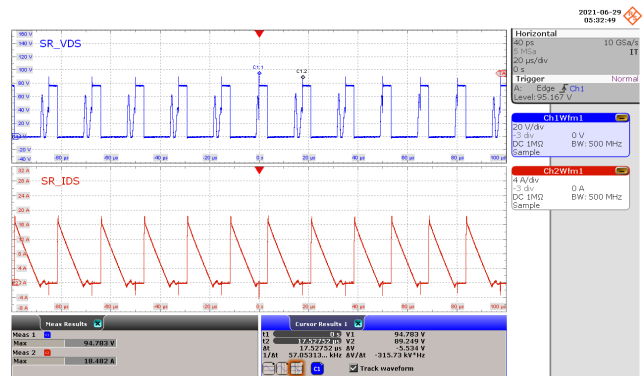

Figure 97 – SR FET Drain Voltage and Current.
 265 VAC, 20.0 V, 5 A Load.
 $V_{DS_SRFET} = 94.7$ V Maximum.
 CH1: V_{DS_SRFET} , 20 V / div.
 CH2: I_{DS_SRFET} , 4 A / div.
 Time: 20 μ s / div.

14.6 Primary and SR FET Drain Voltage and Current (during Output Voltage Transition)

14.6.1 Primary Drain Voltage and Current, 3.3 V to 21 V PPS Transition

Primary Drain Voltage, Drain Current, and output voltage on the board were captured. The USB PD Sink Request was changed from 3.3 V to 21 V / 5 A PPS (PDO6, 100 W Power-Limited) while the load current is at 4.5 A (~95% of current limit).

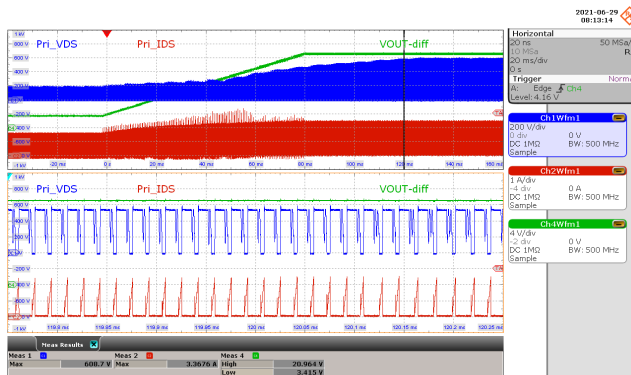

Figure 98 – Primary Drain Voltage and Current.
90 VAC, 3.3 V to 21 V V_{OUT} Transition,
4.5 A Load.
 $V_{DS_PRI} = 608$ V Maximum.
CH1: V_{DS_PRI} , 200 V / div.
CH2: I_{DS_PRI} , 1 A / div.
CH4: V_{OUT} , 4 V / div.
Time: 20 ms / div. (50 μ s / div. Zoom).

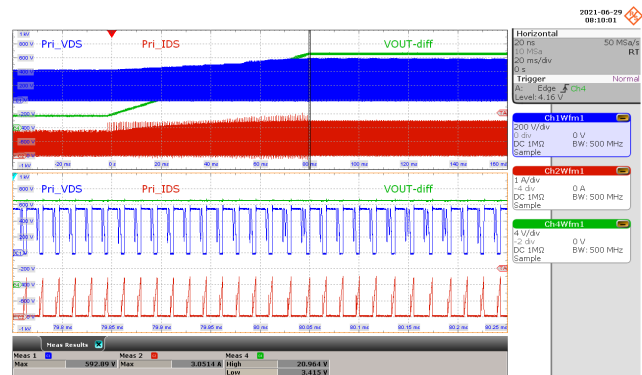

Figure 99 – Primary Drain Voltage and Current.
265 VAC, 3.3 V to 21 V V_{OUT} Transition,
4.5 A Load.
 $V_{DS_PRI} = 592$ V Maximum.
CH1: V_{DS_PRI} , 200 V / div.
CH2: I_{DS_PRI} , 1 A / div.
CH4: V_{OUT} , 4 V / div.
Time: 20 ms / div. (50 μ s / div. Zoom).

14.6.2 SR FET Drain Voltage and Current, 3.3 V to 21 V Transition

SR FET Drain Voltage, Drain Current, and output voltage on the board were captured. The USB PD Sink Request was changed from 3.3 V to 21 V / 5 A PPS (PDO6, 100 W Power-Limited) while the load current is at 4.5 A (95% of current limit).

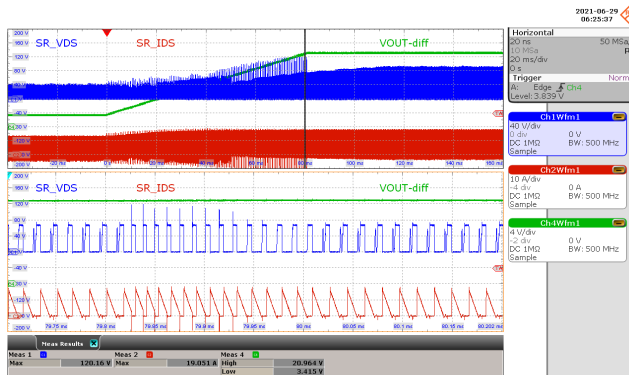

Figure 100 – Primary Drain Voltage and Current.
 90 VAC, 3.3 V to 21 V V_{OUT} Transition,
 4.5 A Load.
 $V_{DS_SRFET} = 120$ V Maximum.
 CH1: V_{DS_SRFET} , 40 V / div.
 CH2: I_{DS_SRFET} , 10 A / div.
 CH4: V_{OUT} , 4 V / div.
 Time: 20 ms / div. (50 μ s / div. Zoom).

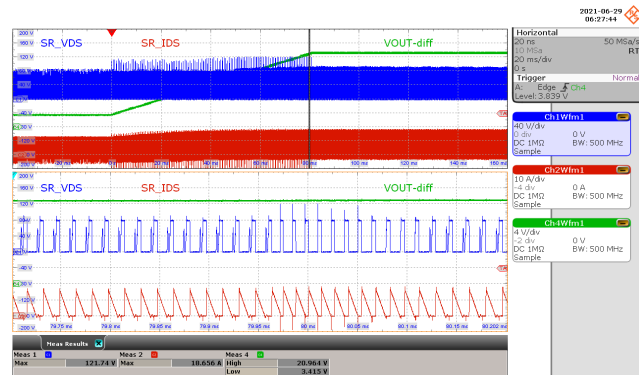

Figure 101 – Primary Drain Voltage and Current.
 265 VAC, 3.3 V to 21 V V_{OUT} Transition,
 4.5 A Load.
 $V_{DS_SRFET} = 121$ V Maximum.
 CH1: V_{DS_SRFET} , 40 V / div.
 CH2: I_{DS_SRFET} , 10 A / div.
 CH4: V_{OUT} , 4 V / div.
 Time: 20 ms / div. (50 μ s / div. Zoom).

14.7 Load Transient Response

Output voltage waveform on the board was captured with dynamic load transient from 10% to 100%. Duration for load states (high = 20 ms; low = 20 ms) was chosen to clearly show steady-state for each load condition. Load slew rate (150 mA / μ s) is based on USB PD 3.0 specification.

USB PD 3.0 specification allows a voltage overshoot/undershoot of ± 0.5 V (vSrcValid) on top of $\pm 5\%$ tolerance from the operating voltage (vSrcNew) within the first 5 ms of applying a load transient (tSrcTransient). Beyond 5 ms, the voltage limits are tightened to $\pm 5\%$ within the operating voltage.

14.7.1 Output: 5 V / 5 A

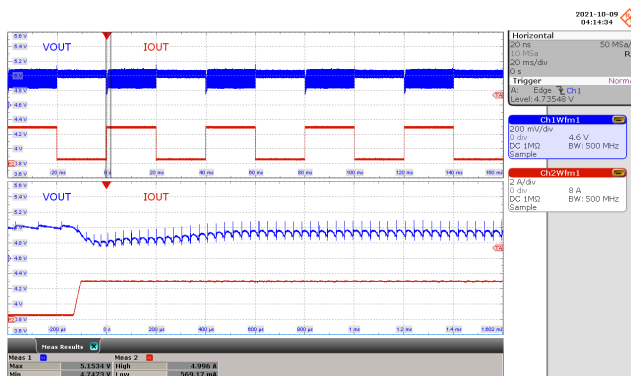

Figure 102 – Transient Response.
 90 VAC, 5.0 V, 0.5 to 5 A Load.
 V_{OUT} = 5.15 V Max., 4.74 V Min.
 CH1: V_{OUT} , 200 mV / div.
 CH2: I_{OUT} , 2 A / div.
 Time: 20 ms / div. (200 μ s / div. Zoom).

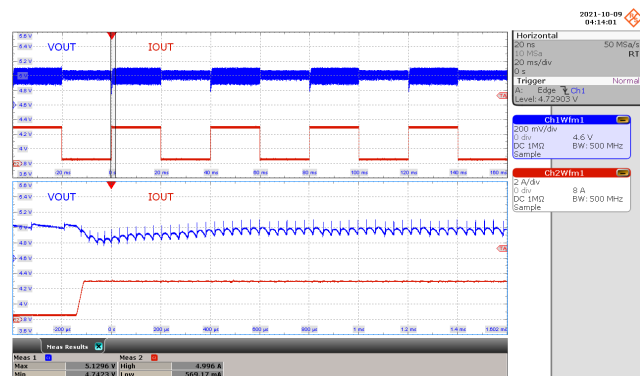

Figure 103 – Transient Response.
 265 VAC, 5.0 V, 0.5 to 5 A Load.
 V_{OUT} = 5.12 V Max., 4.74 V Min.
 CH1: V_{OUT} , 200 mV / div.
 CH2: I_{OUT} , 2 A / div.
 Time: 20 ms / div. (200 μ s / div. Zoom).

14.7.2 Output: 9 V / 5 A

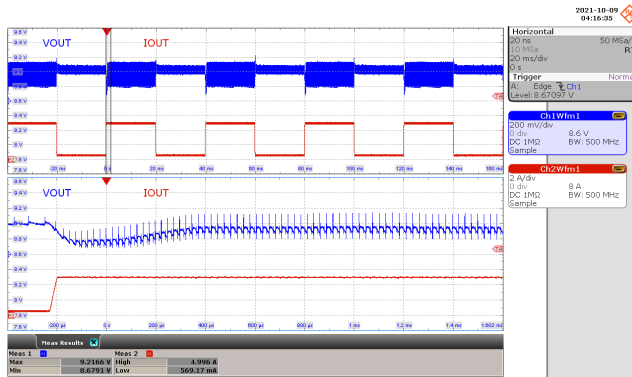

Figure 104 – Transient Response.
 90 VAC, 9.0 V, 0.5 to 5 A Load.
 $V_{OUT} = 9.21$ V Max., 8.67 V Min.
 CH1: V_{OUT} , 200 mV / div.
 CH2: I_{OUT} , 2 A / div.
 Time: 20 ms / div. (200 μ s / div. Zoom).

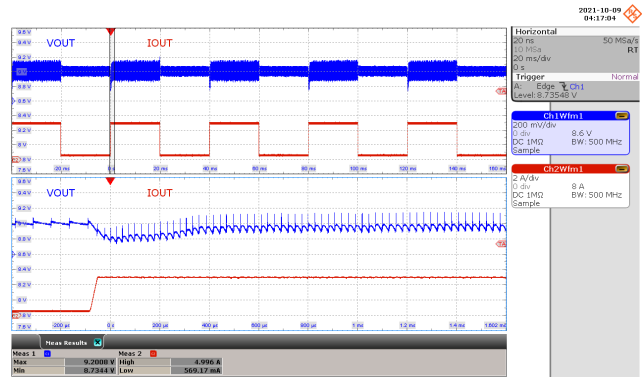

Figure 105 – Transient Response.
 265 VAC, 9.0 V, 0.5 to 5 A Load.
 $V_{OUT} = 9.20$ V Max., 8.73 V Min.
 CH1: V_{OUT} , 200 mV / div.
 CH2: I_{OUT} , 2 A / div.
 Time: 20 ms / div. (200 μ s / div. Zoom).

14.7.3 Output: 12 V / 5 A

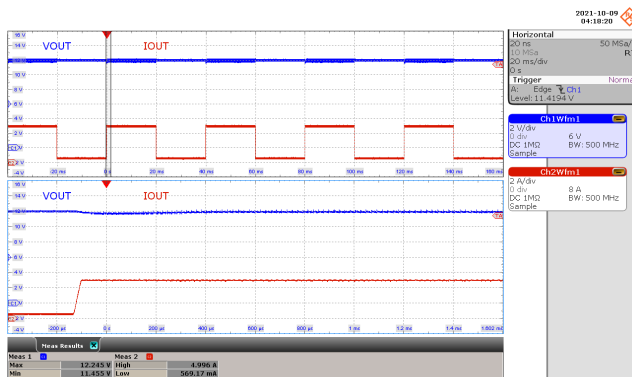

Figure 106 – Transient Response.
 90 VAC, 12.0 V, 0.5 to 5 A Load.
 $V_{OUT} = 12.24$ V Max., 11.45 V Min.
 CH1: V_{OUT} , 2 V / div.
 CH2: I_{OUT} , 2 A / div.
 Time: 20 ms / div. (200 μ s / div. Zoom).

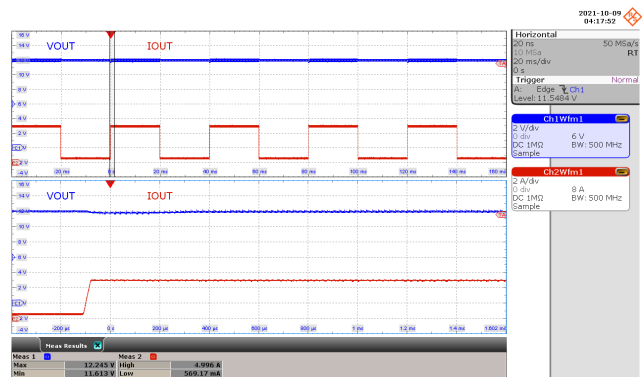

Figure 107 – Transient Response.
 265 VAC, 12.0 V, 0.5 to 5 A Load.
 $V_{OUT} = 12.24$ V Max., 11.61 V Min.
 CH1: V_{OUT} , 2 V / div.
 CH2: I_{OUT} , 2 A / div.
 Time: 20 ms / div. (200 μ s / div. Zoom).

14.7.4 Output: 15 V / 5 A



Figure 108 – Transient Response.
 90 VAC, 15.0 V, 0.5 to 5 A Load.
 $V_{OUT} = 15.24 \text{ V Max.}, 14.61 \text{ V Min.}$
 $CH1: V_{OUT}, 2 \text{ V / div.}$
 $CH2: I_{OUT}, 2 \text{ A / div.}$
 Time: 20 ms / div. (200 μs / div. Zoom).

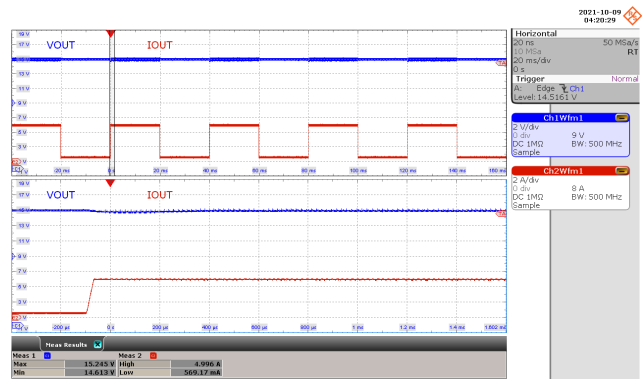

Figure 109 – Transient Response.
 265 VAC, 15.0 V, 0.5 to 5 A Load.
 $V_{OUT} = 15.24 \text{ V Max.}, 14.61 \text{ V Min.}$
 $CH1: V_{OUT}, 2 \text{ V / div.}$
 $CH2: I_{OUT}, 2 \text{ A / div.}$
 Time: 20 ms / div. (200 μs / div. Zoom).

14.7.5 Output: 20 V / 5 A

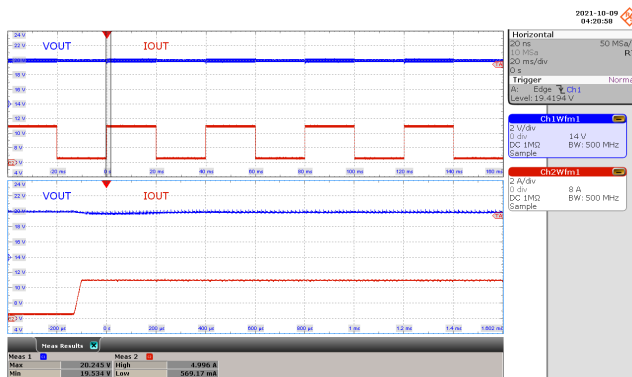

Figure 110 – Transient Response.
 90 VAC, 20.0 V, 0.5 to 5 A Load.
 $V_{OUT} = 20.24 \text{ V Max.}, 19.53 \text{ V Min.}$
 $CH1: V_{OUT}, 2 \text{ V / div.}$
 $CH2: I_{OUT}, 2 \text{ A / div.}$
 Time: 20 ms / div. (200 μs / div. Zoom).

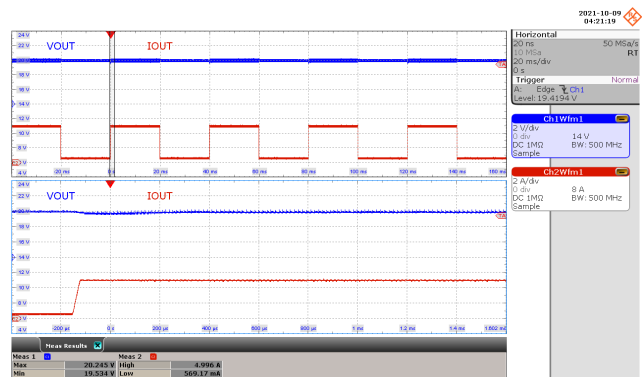

Figure 111 – Transient Response.
 265 VAC, 20.0 V, 0.5 to 5 A Load.
 $V_{OUT} = 20.24 \text{ V Max.}, 19.53 \text{ V Min.}$
 $CH1: V_{OUT}, 2 \text{ V / div.}$
 $CH2: I_{OUT}, 2 \text{ A / div.}$
 Time: 20 ms / div. (200 μs / div. Zoom).

14.8 Output Ripple Measurements

14.8.1 Ripple Measurement Technique

For DC output ripple measurements, a modified oscilloscope test probe must be utilized to reduce spurious signals due to pick-up. Details of the probe modification are provided in the Figures below.

The 4987BA probe adapter is affixed with two capacitors tied in parallel across the probe tip. The capacitors include one (1) 0.1 $\mu\text{F}/50\text{ V}$ ceramic type and one (1) 47 $\mu\text{F}/50\text{ V}$ aluminum electrolytic. The aluminum electrolytic type capacitor is polarized, so proper polarity across DC outputs must be maintained (see below).

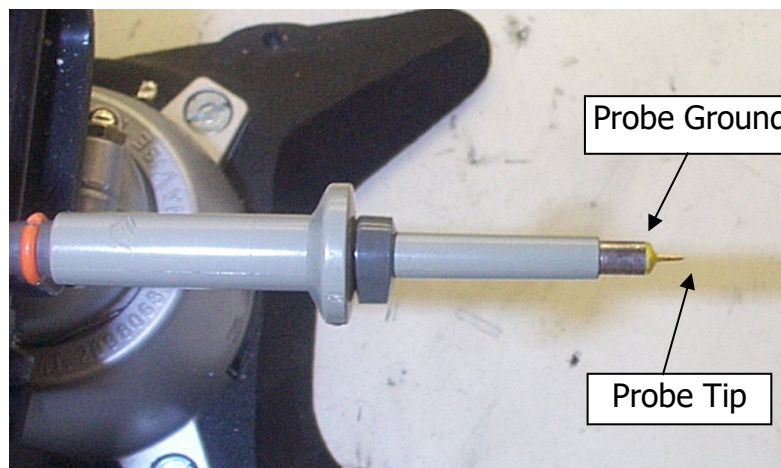

Figure 112 – Oscilloscope Probe Prepared for Ripple Measurement. (End Cap and Ground Lead Removed)

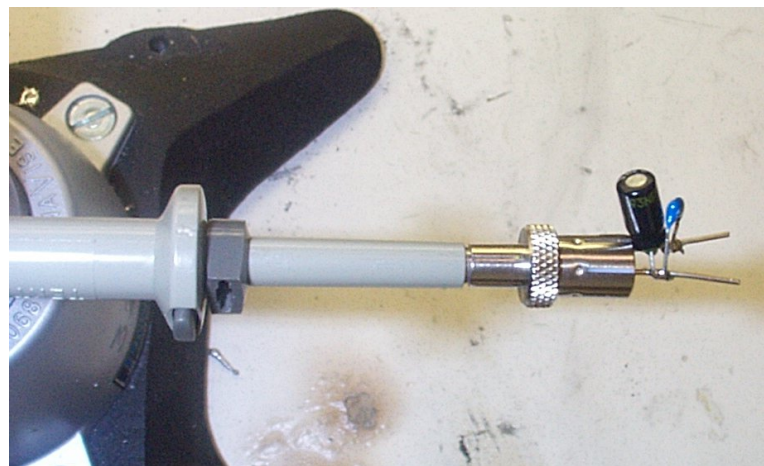

Figure 113 – Oscilloscope Probe with Probe Master (www.probemaster.com) 4987A BNC Adapter. (Modified with wires for ripple measurement, and two parallel decoupling capacitors added)

14.8.2 Output Voltage Ripple Waveforms

Output voltage ripple waveform at full load was captured at the end of 100 mΩ cable using the ripple measurement probe with decoupling capacitors.

14.8.2.1 Output: 5 V / 5 A

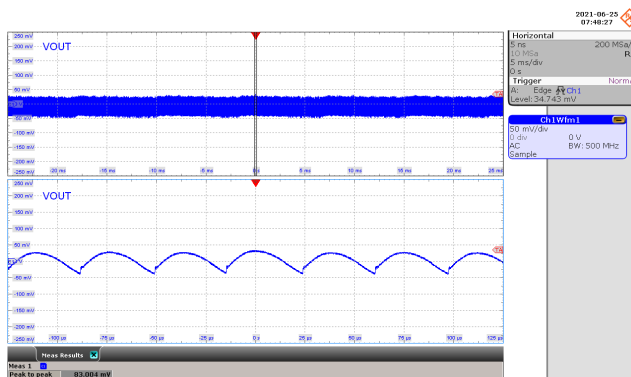

Figure 114 – Output Voltage Ripple.
 90 VAC, 5.0 V, 5 A Load.
 $V_{OUT(AC)}$ = 83 mV Peak-to-Peak.
 CH1: $V_{OUT(AC)}$, 50 mV / div.
 Time: 5 ms / div. (25 μs / div. Zoom).

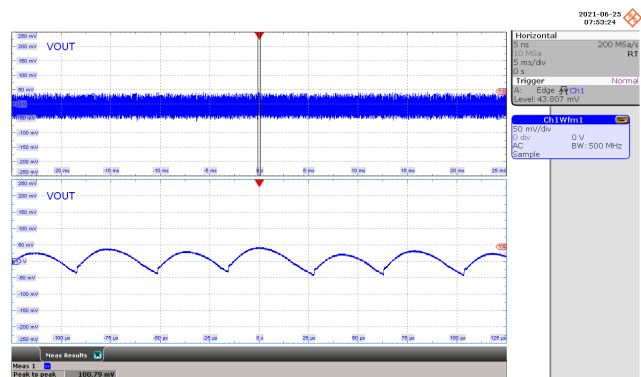

Figure 115 – Output Voltage Ripple.
 265 VAC, 5.0 V, 5 A Load.
 $V_{OUT(AC)}$ = 100 mV Peak-to-Peak.
 CH1: $V_{OUT(AC)}$, 50 mV / div.
 Time: 5 ms / div. (25 μs / div. Zoom).

14.8.2.2 Output: 9 V / 5 A

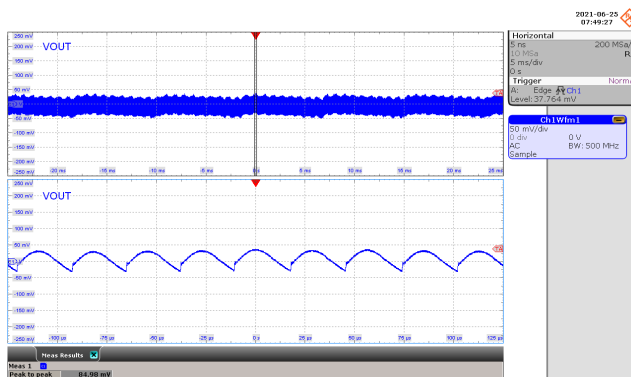

Figure 116 – Output Voltage Ripple.
 90 VAC, 9.0 V, 5 A Load.
 $V_{OUT(AC)}$ = 84 mV Peak-to-Peak.
 CH1: $V_{OUT(AC)}$, 50 mV / div.
 Time: 5 ms / div. (25 μs / div. Zoom).

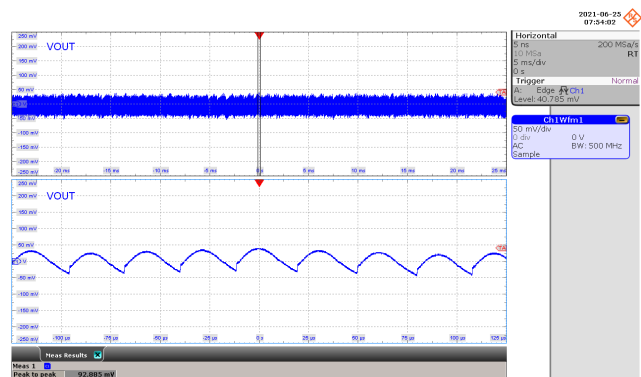

Figure 117 – Output Voltage Ripple.
 265 VAC, 9.0 V, 5 A Load.
 $V_{OUT(AC)}$ = 92 mV Peak-to-Peak.
 CH1: $V_{OUT(AC)}$, 50 mV / div.
 Time: 5 ms / div. (25 μs / div. Zoom).

14.8.2.3 Output: 12 V / 5 A

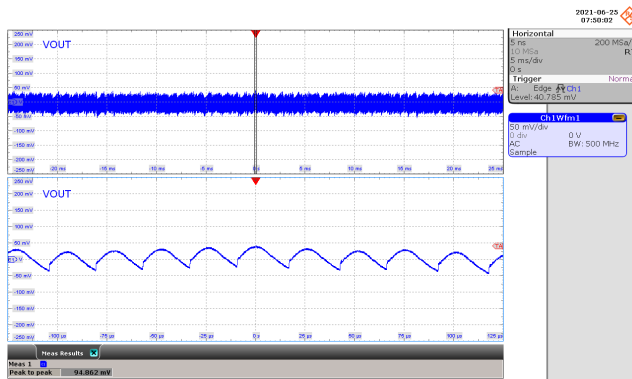

Figure 118 – Output Voltage Ripple.
 90 VAC, 12.0 V, 5 A Load.
 $V_{OUT(AC)} = 94 \text{ mV Peak-to-Peak}$.
 CH1: $V_{OUT(AC)}$, 50 mV / div.
 Time: 5 ms / div. (25 μs / div. Zoom).

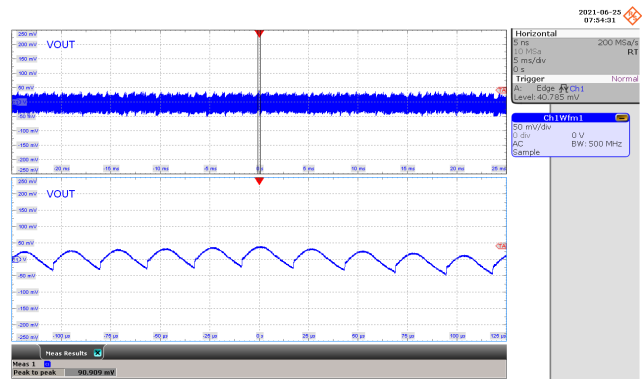

Figure 119 – Output Voltage Ripple.
 265 VAC, 12.0 V, 5 A Load.
 $V_{OUT(AC)} = 90 \text{ mV Peak-to-Peak}$.
 CH1: $V_{OUT(AC)}$, 50 mV / div.
 Time: 5 ms / div. (25 μs / div. Zoom).

14.8.2.4 Output: 15 V / 5 A

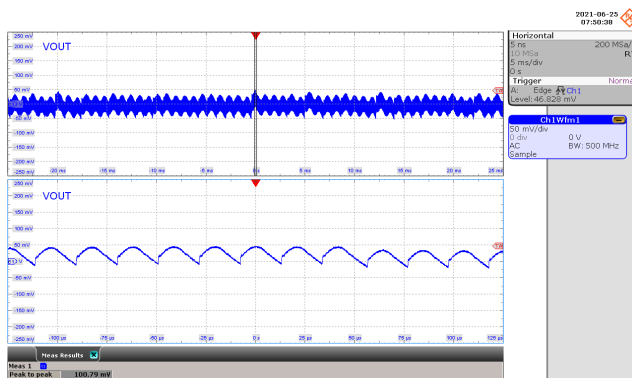

Figure 120 – Output Voltage Ripple.
 90 VAC, 15.0 V, 5 A Load.
 $V_{OUT(AC)} = 100 \text{ mV Peak-to-Peak}$.
 CH1: $V_{OUT(AC)}$, 50 mV / div.
 Time: 5 ms / div. (25 μs / div. Zoom).

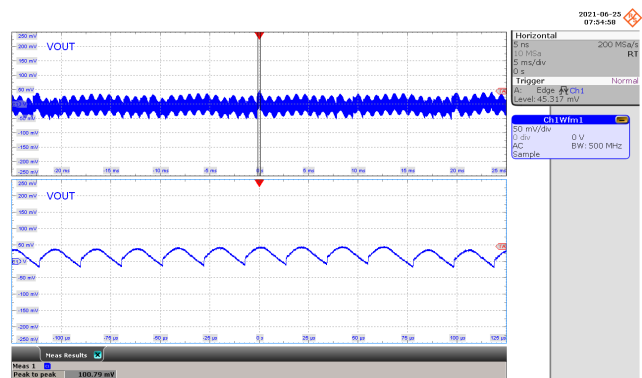

Figure 121 – Output Voltage Ripple.
 265 VAC, 15.0 V, 5 A Load.
 $V_{OUT(AC)} = 100 \text{ mV Peak-to-Peak}$.
 CH1: $V_{OUT(AC)}$, 50 mV / div.
 Time: 5 ms / div. (25 μs / div. Zoom).

14.8.2.5 Output: 20 V / 5 A

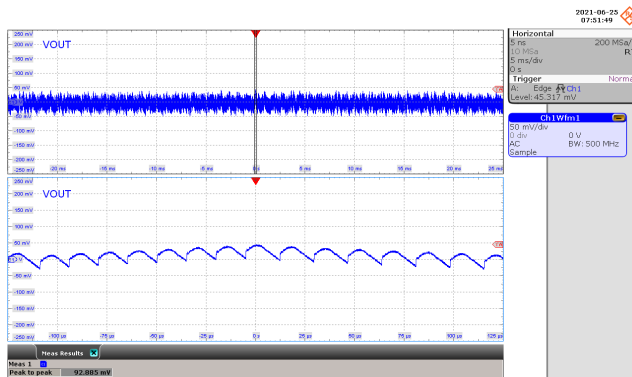

Figure 122 – Output Voltage Ripple.
 90 VAC, 20.0 V, 5 A Load.
 $V_{OUT(AC)} = 92$ mV Peak-to-Peak.
 CH1: $V_{OUT(AC)}$, 50 mV / div.
 Time: 5 ms / div. (25 μ s / div. Zoom).

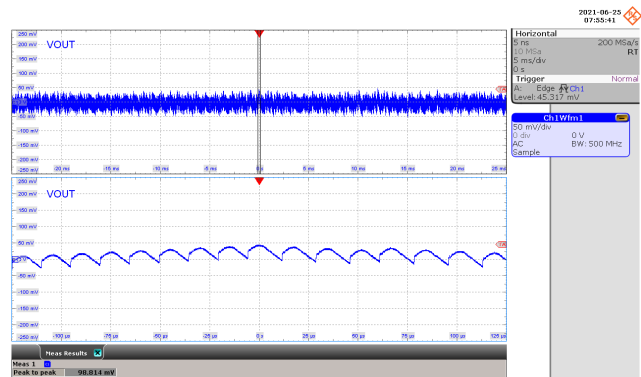

Figure 123 – Output Voltage Ripple.
 265 VAC, 20.0 V, 5 A Load.
 $V_{OUT(AC)} = 98$ mV Peak-to-Peak.
 CH1: $V_{OUT(AC)}$, 50 mV / div.
 Time: 5 ms / div. (25 μ s / div. Zoom).

14.8.3 Output Voltage Ripple Amplitude vs. Load

14.8.3.1 Output: 5 V / 5 A

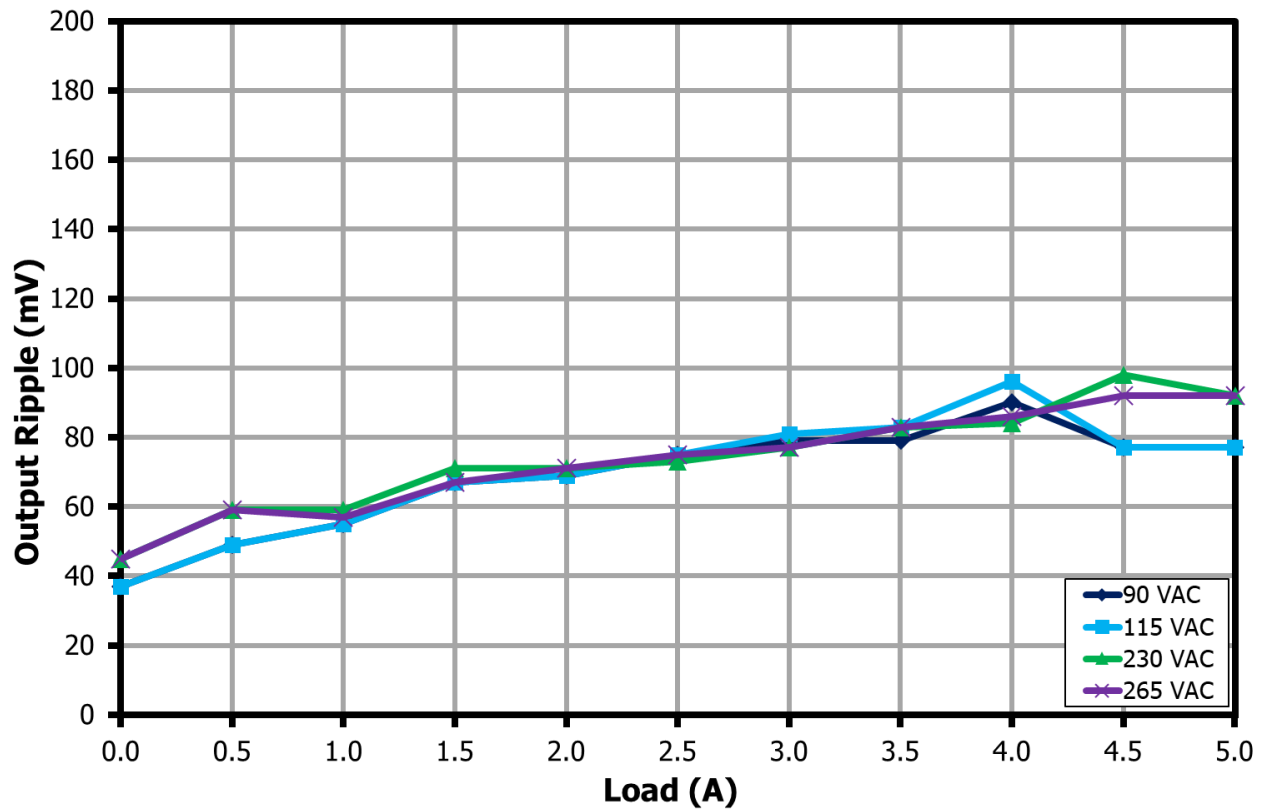

Figure 124 – Peak-to-Peak Output Voltage Ripple Amplitude vs. Load for 5 V Output.

14.8.3.2 Output: 9 V / 5 A

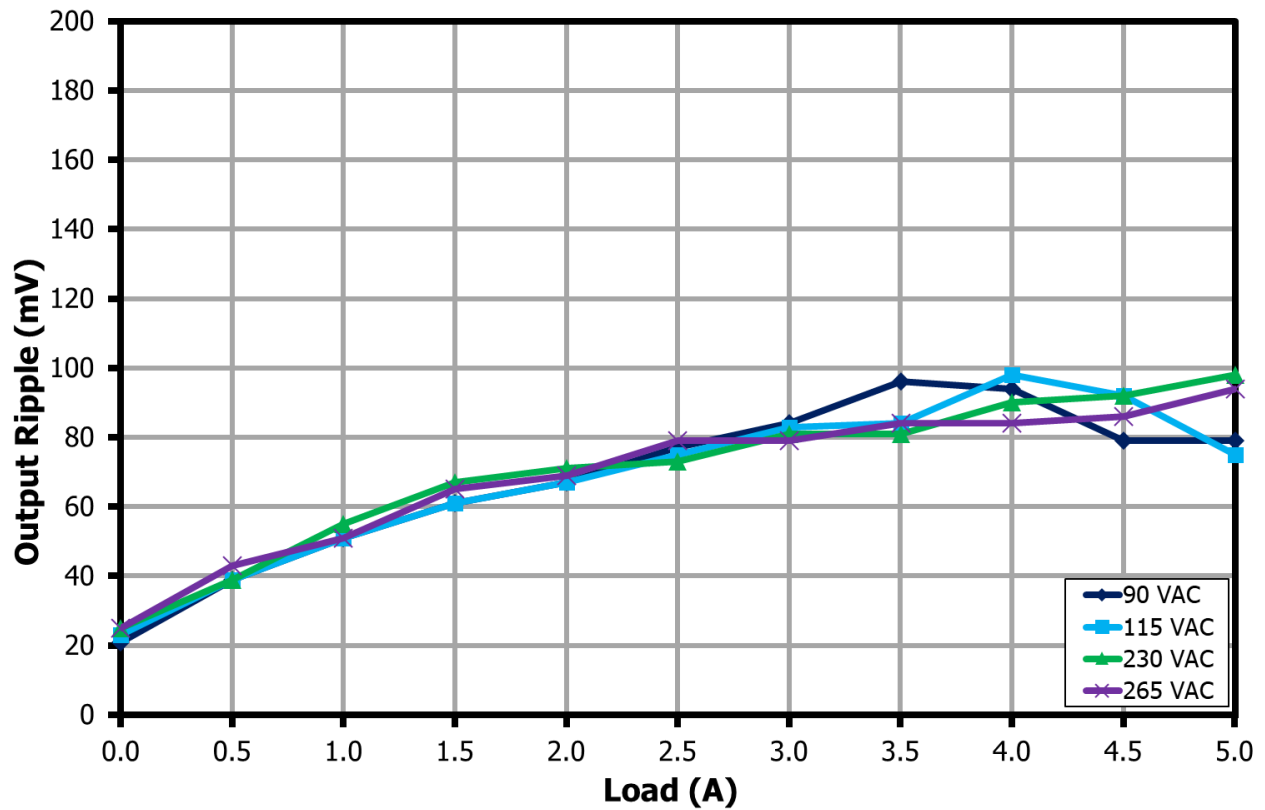

Figure 125 – Peak-to-Peak Output Voltage Ripple Amplitude vs. Load for 9 V Output.

14.8.3.3 Output: 12 V / 5 A

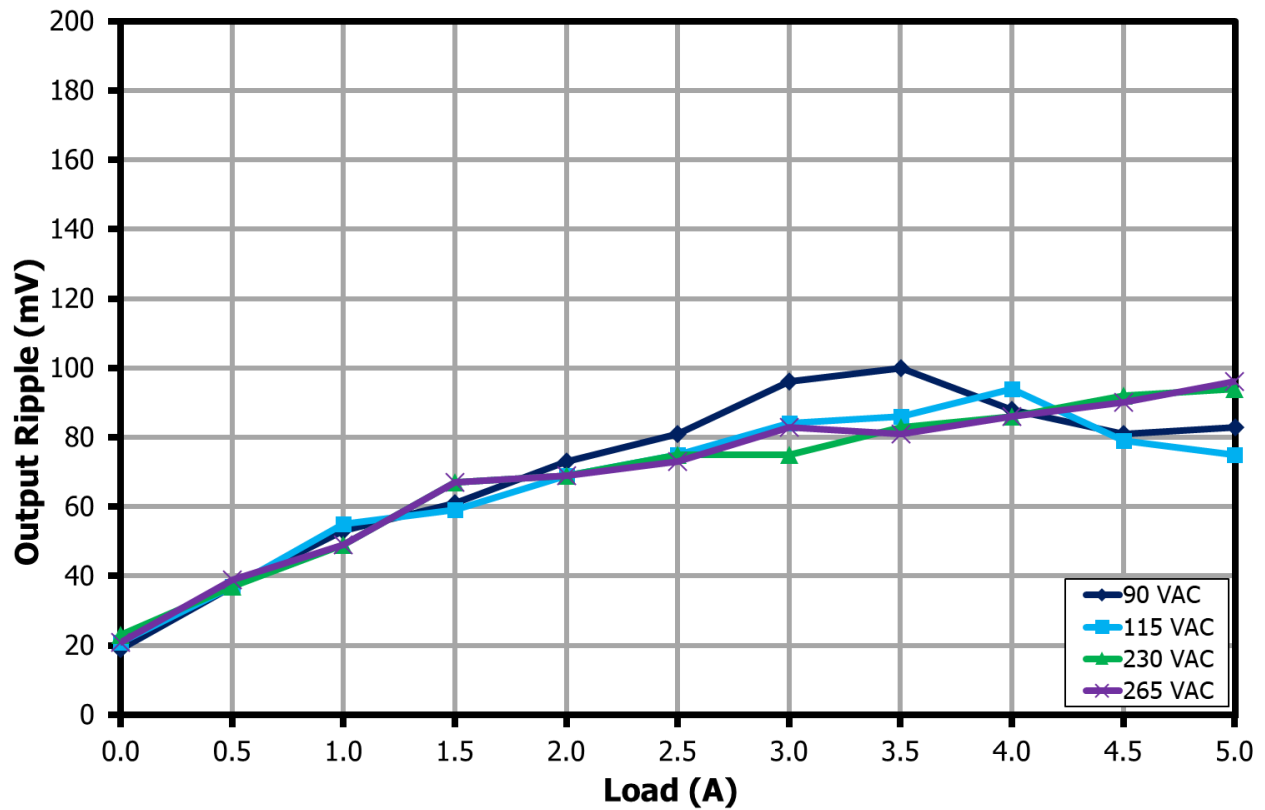

Figure 126 – Peak-to-Peak Output Voltage Ripple Amplitude vs. Load for 12 V Output.

14.8.3.4 Output: 15 V / 5 A

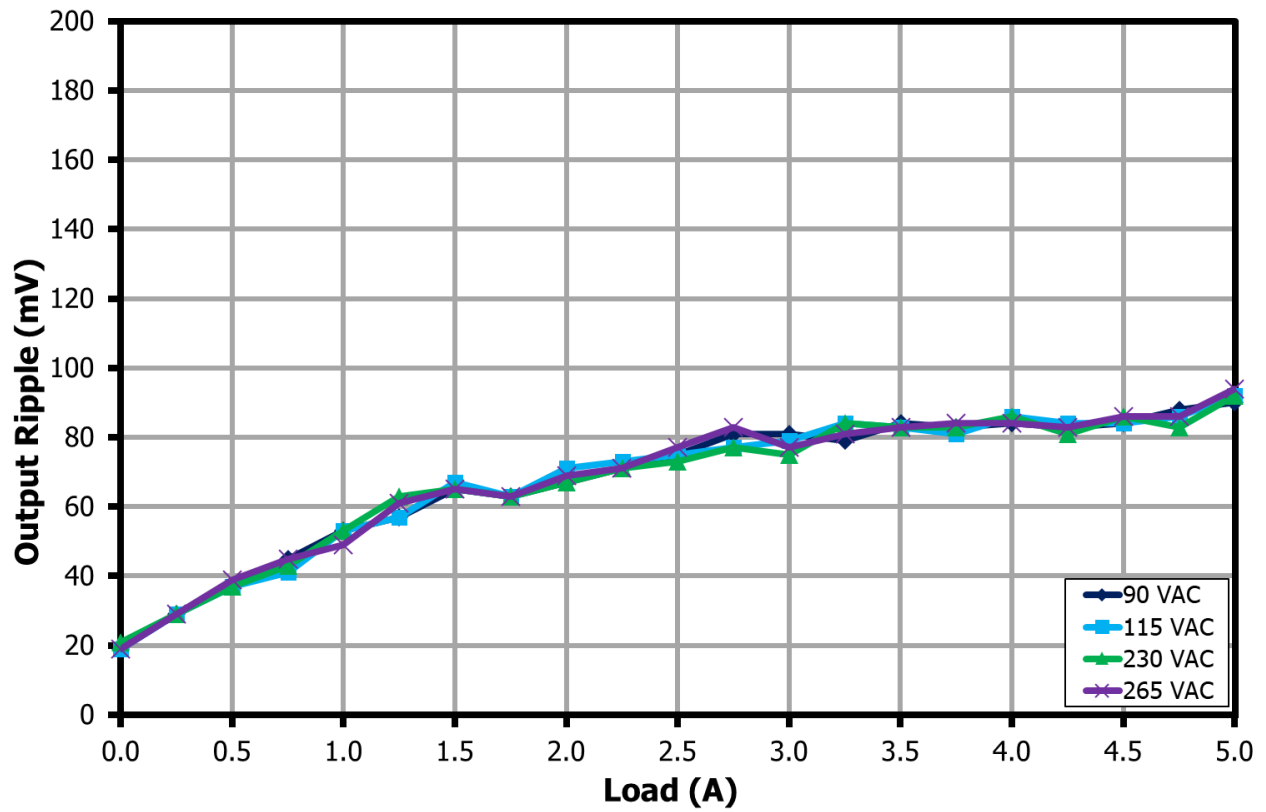

Figure 127 – Peak-to-Peak Output Voltage Ripple Amplitude vs. Load for 15 V Output.

14.8.3.5 Output: 20 V / 5 A

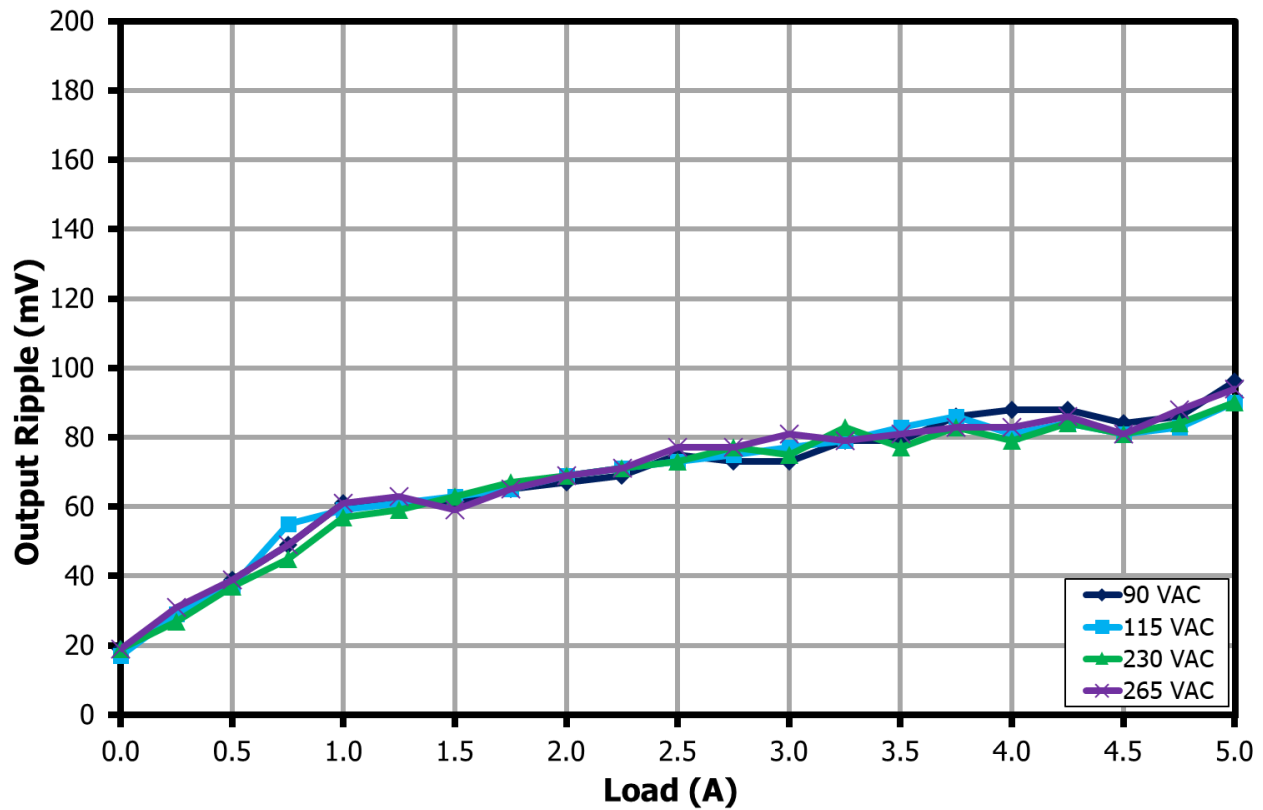

Figure 128 – Peak-to-Peak Output Voltage Ripple Amplitude vs. Load for 20 V Output.

15 CV/CC Profile

One Programmable Power Supply (PPS) Augmented Power Data Object (APDO) is supported in this design:

- PDO6: 3.3 V – 21 V / 5 A PPS (100 W power-limited)

CVCC profiles were taken with the output voltage measured on the board.

15.1 Output: 20 V / 5 A PPS Request, PDO6 (100 W Power-Limited)

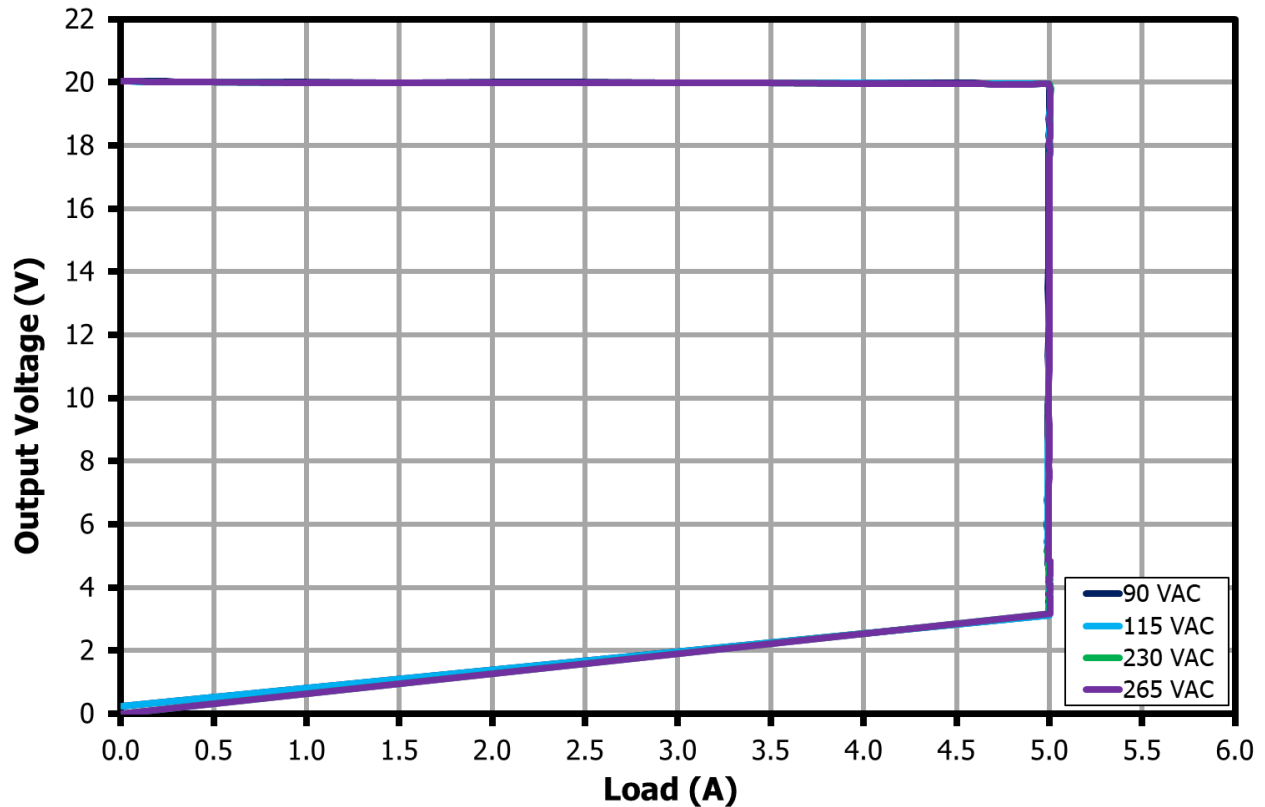
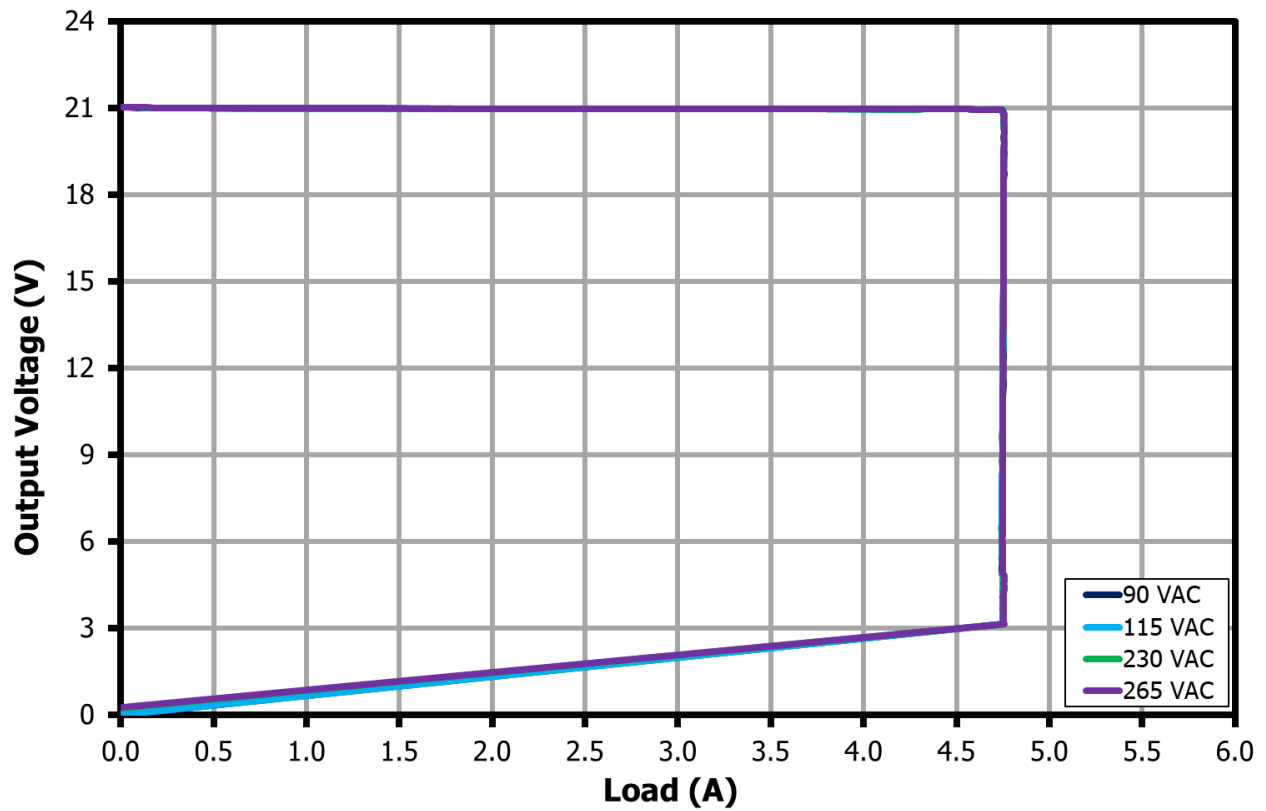

Figure 129 – CV/CC Profile for 20 V / 5 A PPS Request.

15.2 Output: 21 V / 5 A PPS Request, PDO6 (100 W Power-Limited)**Figure 130** – CV/CC Profile for 21 V / 5 A PPS Request.

16 Voltage Step and Current Limit Test using QuadraMAX and Total Phase Analyzer

The power supply was evaluated and passed both QuadraMAX PPS Voltage Step Test (VST) and PPS Current Limit Test (CLT). The output voltage and current during VST and CLT as recorded by the Total Phase Analyzer are presented below.

16.1 Voltage Step Test (VST)

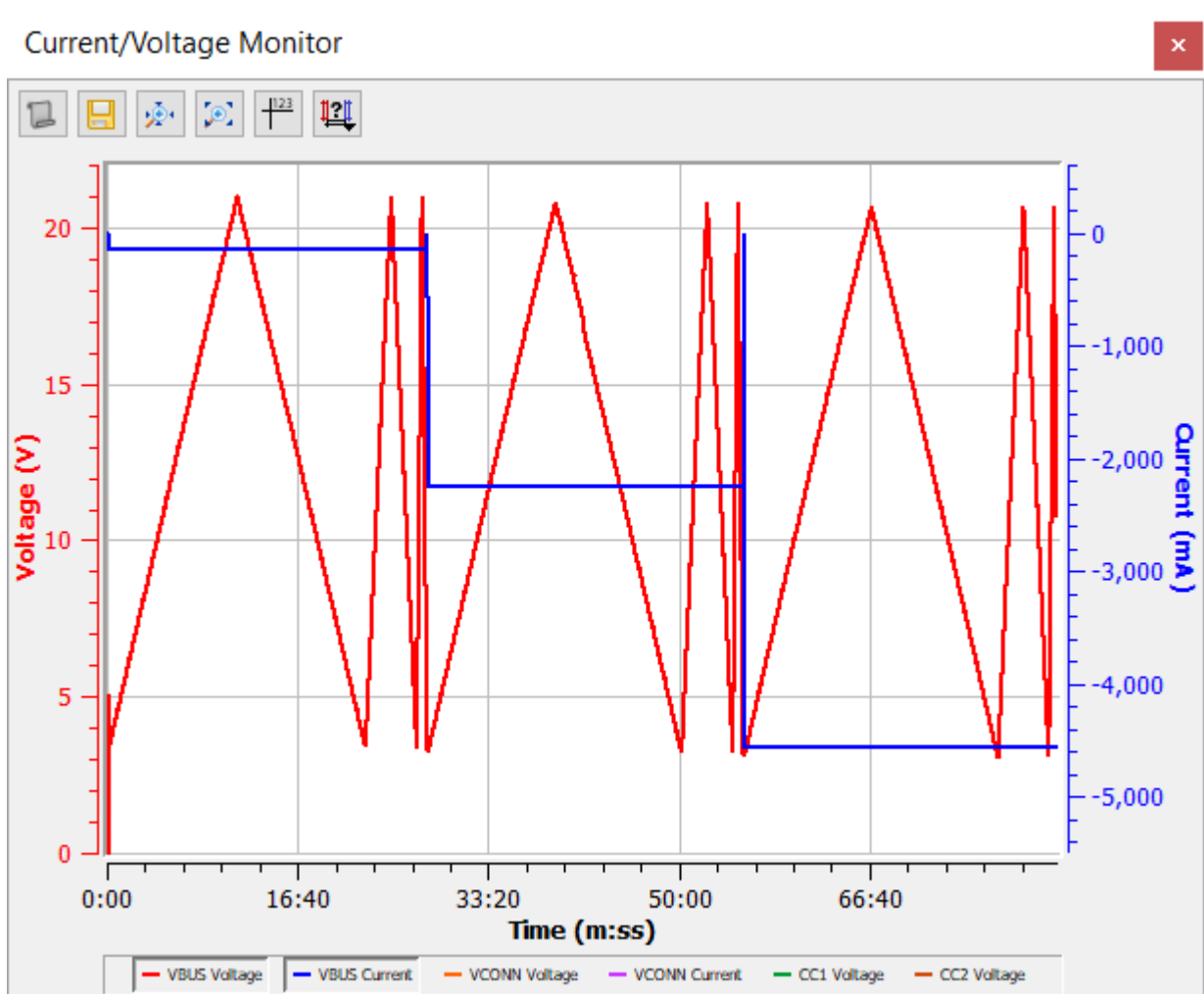

Figure 131 – Plot of SPT.6 VST from Total Phase Analyzer.

16.2 Current Limit Test (CLT)

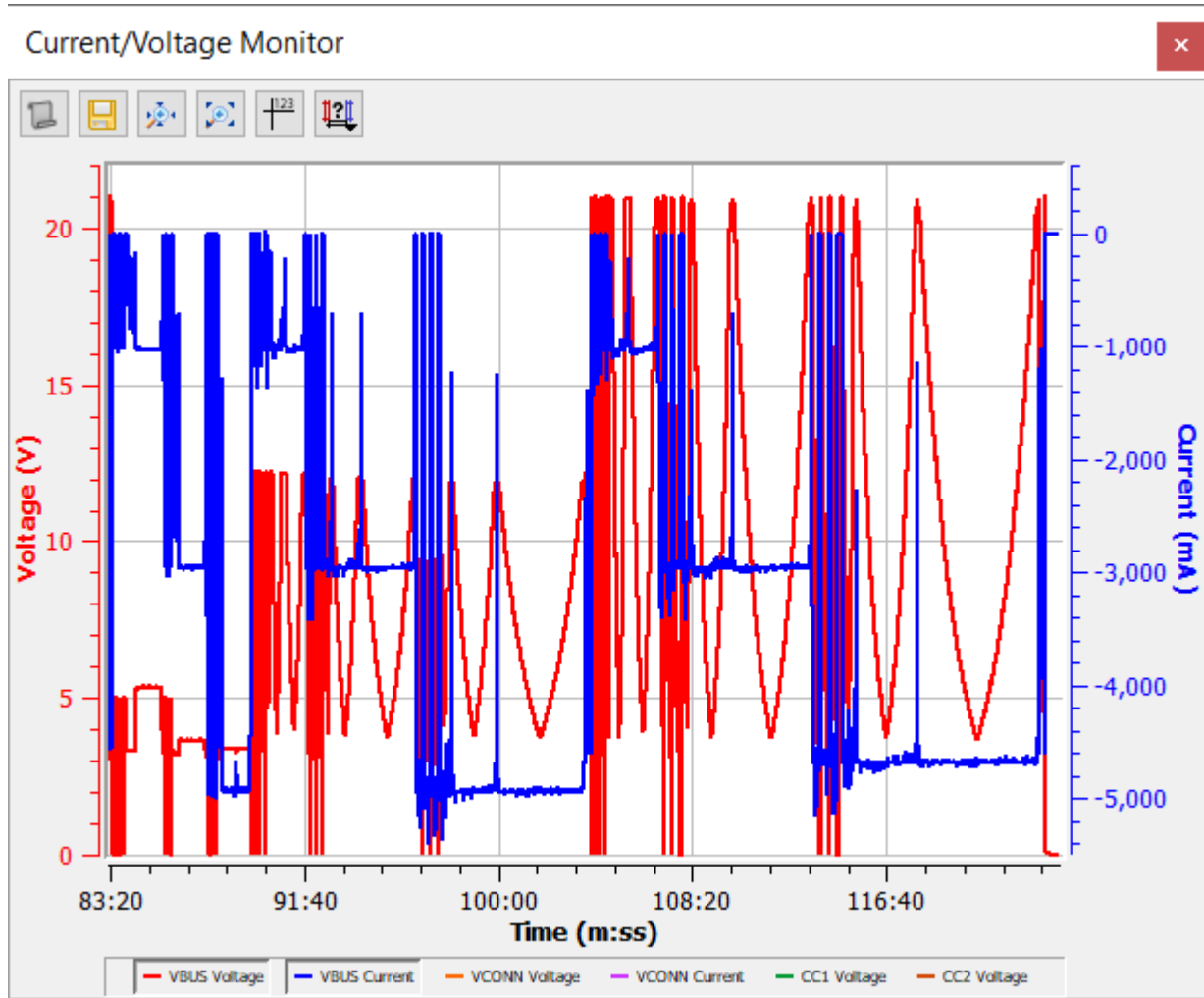
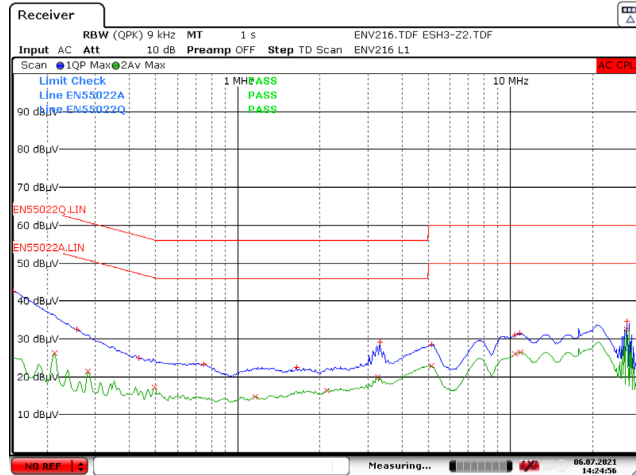

Figure 132 – Plot of SPT.7 CLT from Total Phase Analyzer.

17 Conducted EMI

17.1 Floating Ground (QPK / AV)

17.1.1 Output: 5 V / 5 A



Date: 6.JUL.2021 14:24:57

115 VAC.

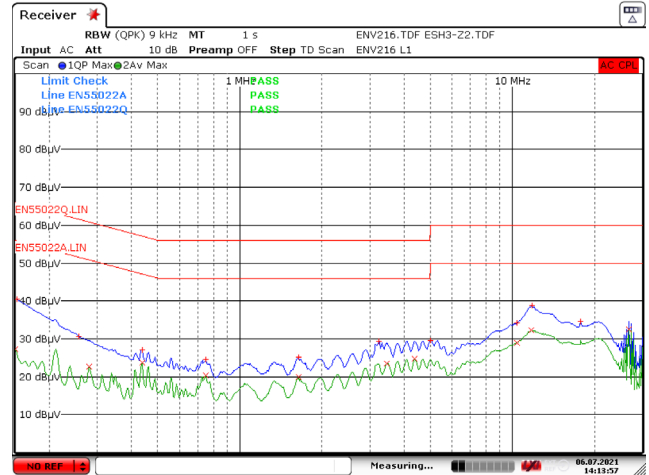

Date: 6.JUL.2021 14:13:57

230 VAC.

Figure 133 – Floating Ground EMI, 5 V / 5 A Load [Line Scan].

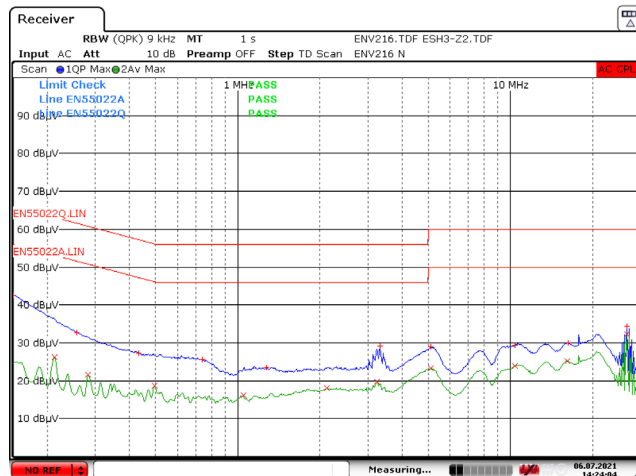

Date: 6.JUL.2021 14:24:04

115 VAC.

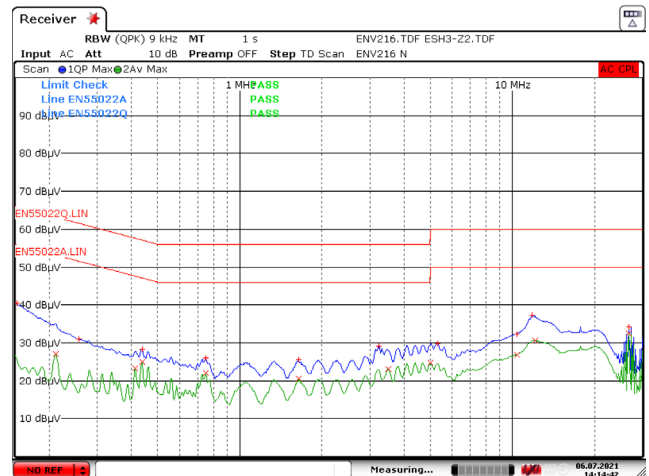

Date: 6.JUL.2021 14:14:42

230 VAC.

Figure 134 – Floating Ground EMI, 5 V / 5 A Load [Neutral Scan].

17.1.2 Output: 9 V / 5 A

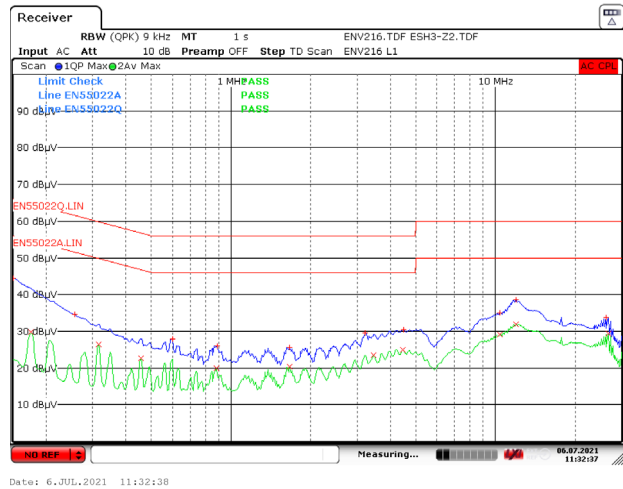
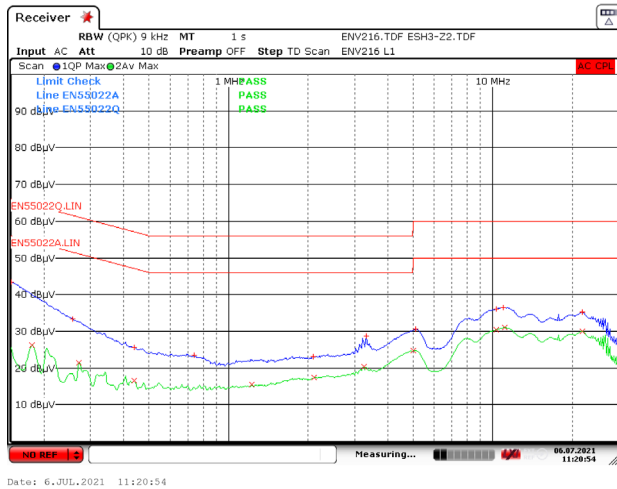

115 VAC.

230 VAC.

Figure 135 – Floating Ground EMI, 9 V / 5 A Load [Line Scan].

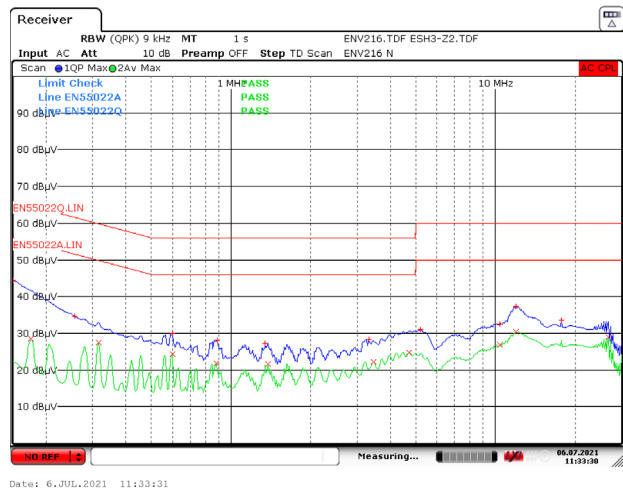
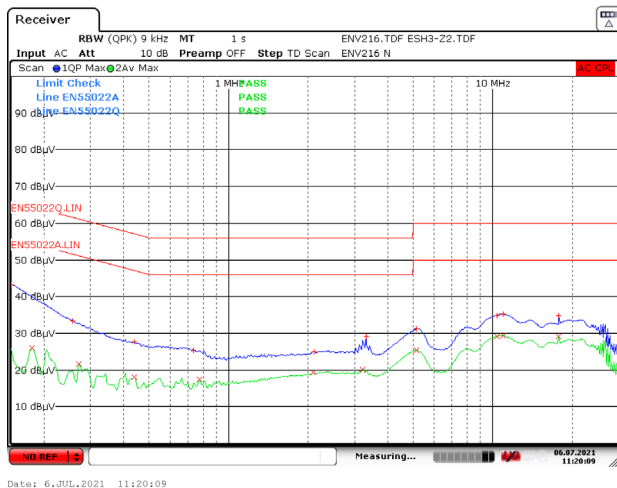

115 VAC.

230 VAC.

Figure 136 – Floating Ground EMI, 9 V / 5 A Load [Neutral Scan].

17.1.3 Output: 12 V / 5 A

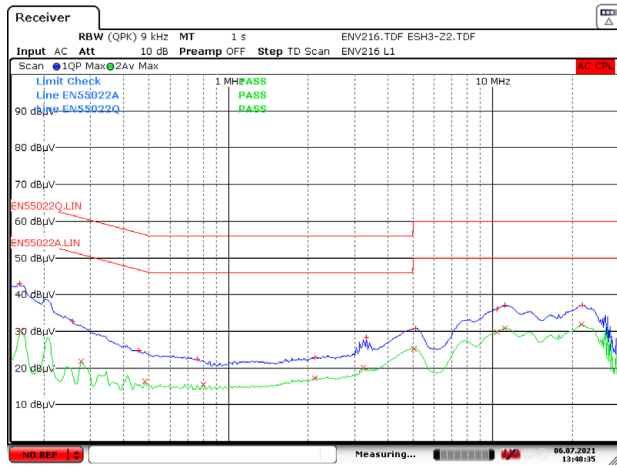

Date: 6.JUL.2021 13:48:35

115 VAC.

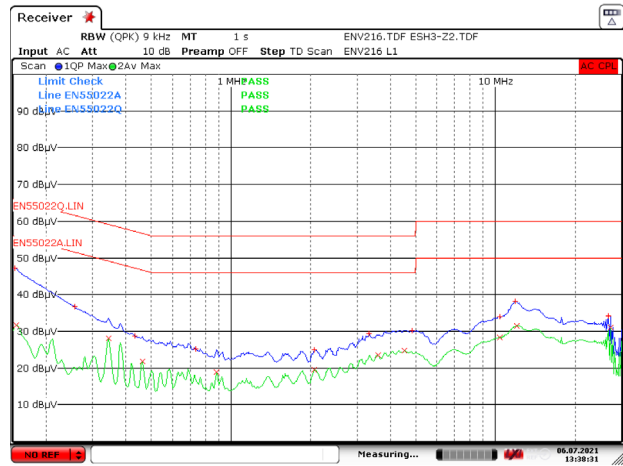

Date: 6.JUL.2021 13:38:31

230 VAC.

Figure 137 – Floating Ground EMI, 12 V / 5 A Load [Line Scan].

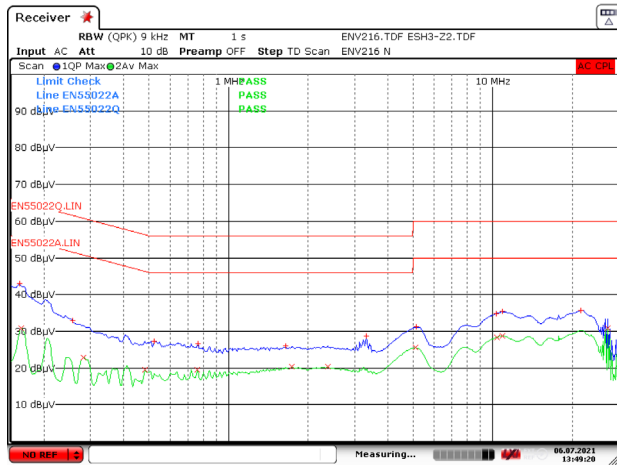

Date: 6.JUL.2021 13:49:20

115 VAC.

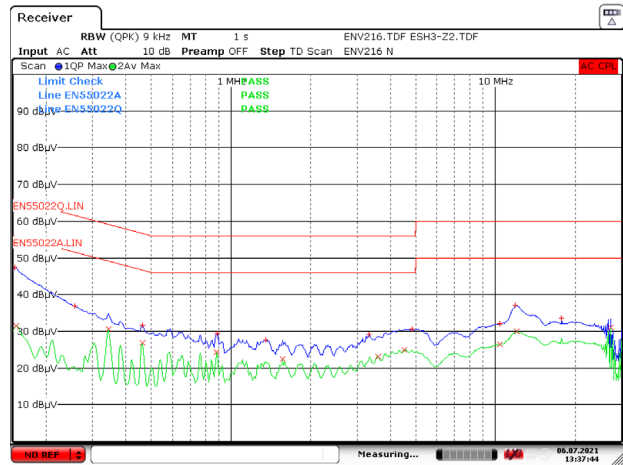

Date: 6.JUL.2021 13:37:44

230 VAC.

Figure 138 – Floating Ground EMI, 12 V / 5 A Load [Neutral Scan].

17.1.4 Output: 15 V / 5 A

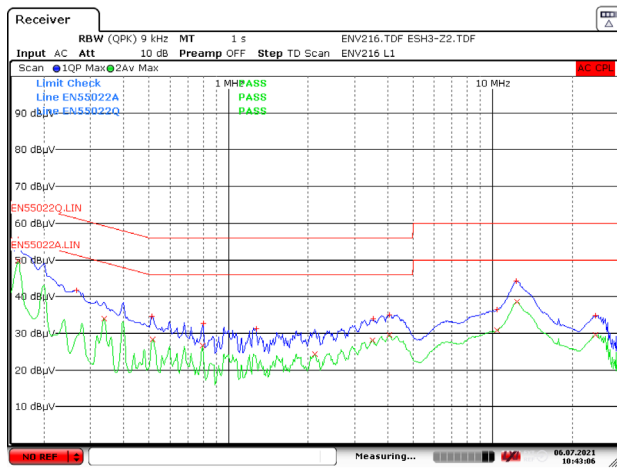

Date: 6.JUL.2021 10:43:07

115 VAC.

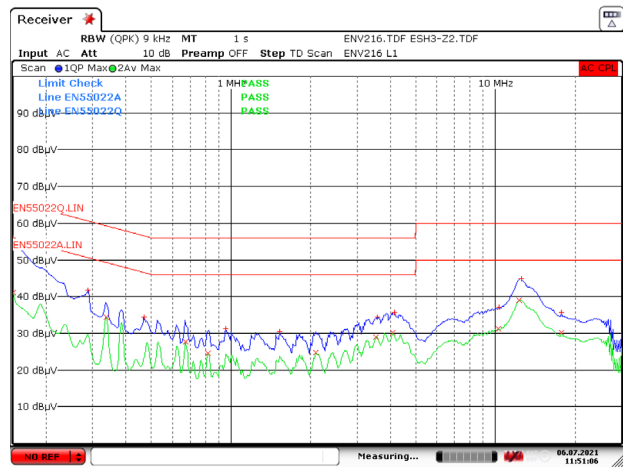

Date: 6.JUL.2021 11:51:07

230 VAC.

Figure 139 – Floating Ground EMI, 15 V / 5 A Load [Line Scan].

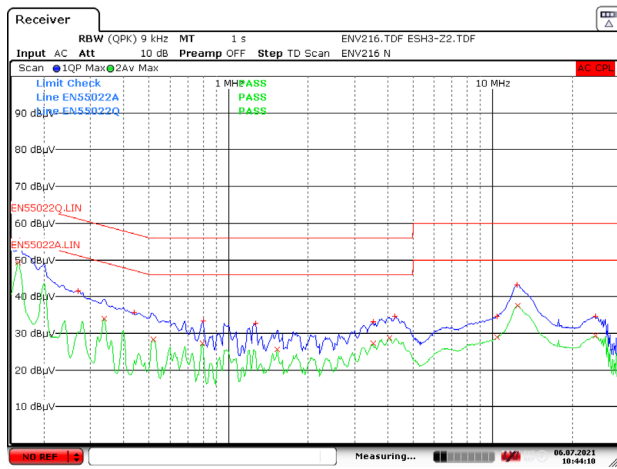

Date: 6.JUL.2021 10:44:11

115 VAC.

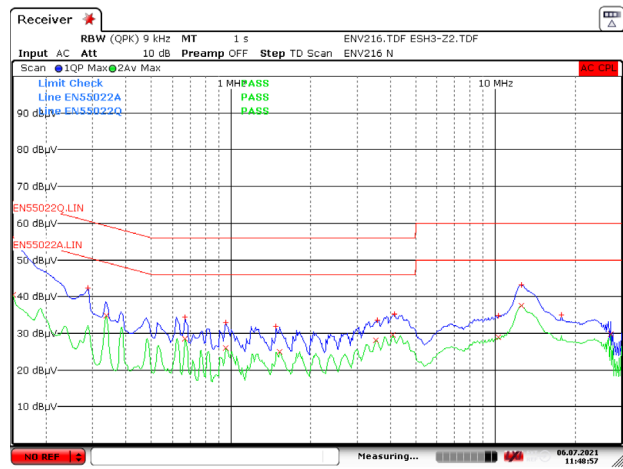

Date: 6.JUL.2021 11:48:58

230 VAC.

Figure 140 – Floating Ground EMI, 15 V / 5 A Load [Neutral Scan].

17.1.5 Output: 20 V / 5 A

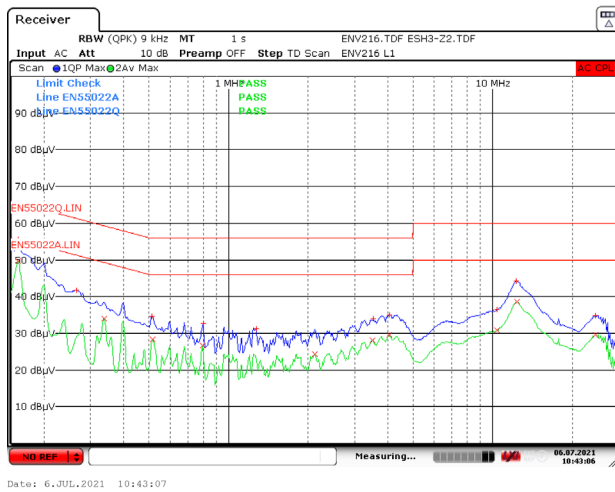

115 VAC.

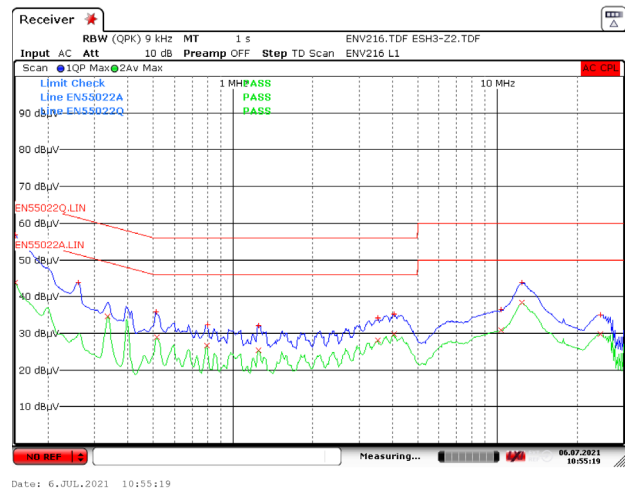

230 VAC.

Figure 141 – Floating Ground EMI, 20 V / 5 A Load [Line Scan].

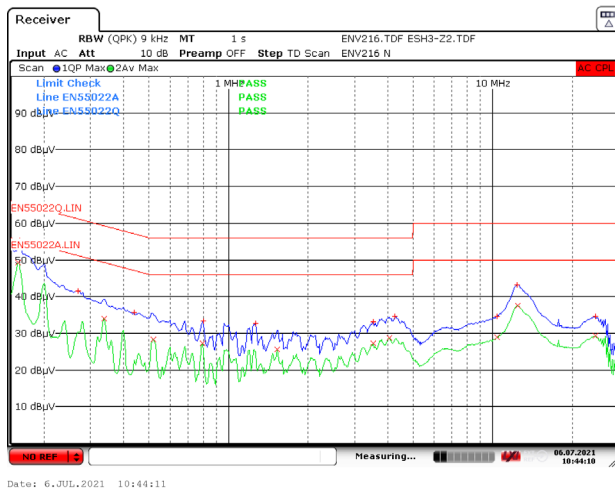

115 VAC.

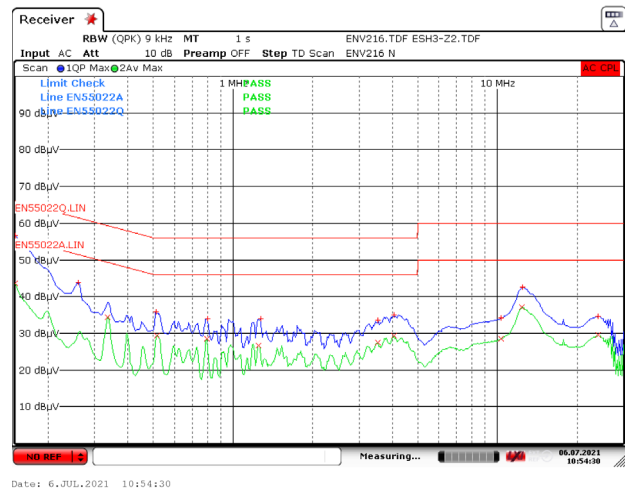

230 VAC.

Figure 142 – Floating Ground EMI, 20 V / 5 A Load [Neutral Scan].

18 Combination Wave Surge

The unit was subjected to ± 1000 V differential mode and ± 2000 V common mode combination wave surge at several line phase angles with 10 strikes for each condition.

A test failure was defined as an output latch-off that needs operator intervention to recover, or a complete loss of function that is not recoverable.

18.1 Differential Mode Surge (L1 to L2), 230 VAC Input

Surge Level (V)	Injection Location	Injection Phase (°)	Test Result 5 V / 0 A without PD Sink	Test Result 20 V / 5 A
+1000	L1 to L2	0	Pass	Pass
-1000	L1 to L2	0	Pass	Pass
+1000	L1 to L2	90	Pass	Pass
-1000	L1 to L2	90	Pass	Pass
+1000	L1 to L2	270	Pass	Pass
-1000	L1 to L2	270	Pass	Pass

18.2 Common Mode Surge (L1, L2 to PE), 230 VAC Input

Surge Level (V)	Injection Location	Injection Phase (°)	Test Result 5 V / 0 A without PD Sink	Test Result 20 V / 5 A
+2000	L1, L2 to PE	0	Pass	Pass
-2000	L1, L2 to PE	0	Pass	Pass
+2000	L1, L2 to PE	90	Pass	Pass
-2000	L1, L2 to PE	90	Pass	Pass
+2000	L1, L2 to PE	270	Pass	Pass
-2000	L1, L2 to PE	270	Pass	Pass

18.3 Common Mode Surge (L1 to PE), 230 VAC Input

Surge Level (V)	Injection Location	Injection Phase (°)	Test Result 5 V / 0 A without PD Sink	Test Result 20 V / 5 A
+2000	L1 to PE	0	Pass	Pass
-2000	L1 to PE	0	Pass	Pass
+2000	L1 to PE	90	Pass	Pass
-2000	L1 to PE	90	Pass	Pass
+2000	L1 to PE	270	Pass	Pass
-2000	L1 to PE	270	Pass	Pass

18.4 *Common Mode Surge (L2 to PE), 230 VAC Input*

Surge Level (V)	Injection Location	Injection Phase (°)	Test Result 5 V / 0 A without PD Sink	Test Result 20 V / 5 A
+2000	L2 to PE	0	Pass	Pass
-2000	L2 to PE	0	Pass	Pass
+2000	L2 to PE	90	Pass	Pass
-2000	L2 to PE	90	Pass	Pass
+2000	L2 to PE	270	Pass	Pass
-2000	L2 to PE	270	Pass	Pass

19 Electrostatic Discharge

The unit was tested with ± 8.0 kV to ± 16.5 kV air discharge and ± 8.0 to ± 8.8 kV contact discharge with 10 strikes for each condition at the following locations:

- End of cable +VOUT and GND
- End of cable USB PD Sink CC Lines
- On-board +VOUT and GND

A test failure was defined as an output latch-off that needs operator intervention to recover, or a complete loss of function that is not recoverable.

19.1 VOUT and GND ESD Performance

Discharge points were added on the board and at the end of cable on the USB PD Sink (TinyPAT) to test VOUT and GND ESD performance. A 1-meter 5 A USB Type C cable with e-marker (Veckle) was used to support 100 W load.

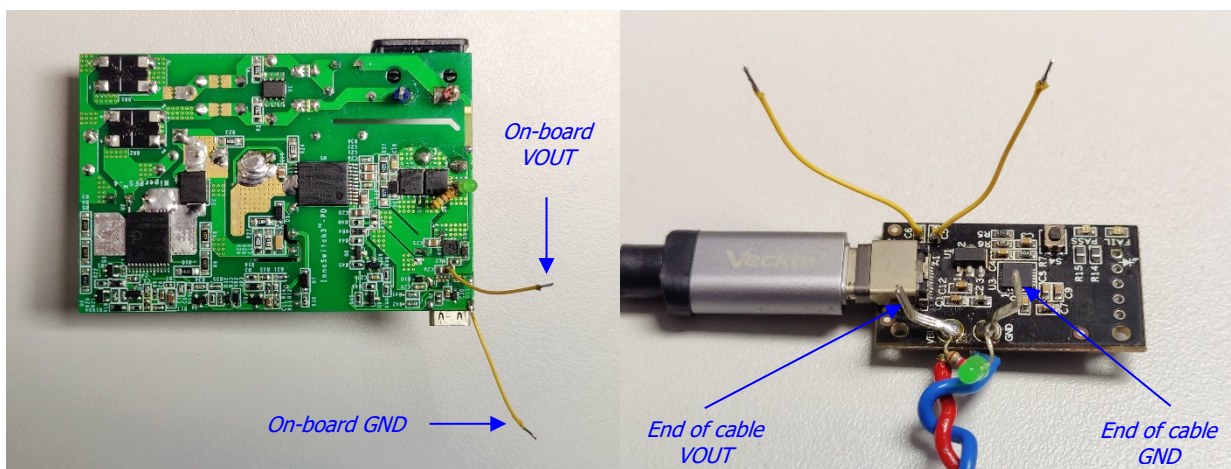

Figure 143 – ESD Discharge Points.

19.1.1 Air Discharge, End of Cable, 230 VAC Input

Discharge Voltage (kV)	ESD Strike Location (10 Strikes Each)	Test Result 20 V / 5 A	Test Result 5 V / 0 A with PD Sink
+8	+VOUT	Pass	Pass
	GND	Pass	Pass
-8	+VOUT	Pass	Pass
	GND	Pass	Pass
+10	+VOUT	Pass	Pass
	GND	Pass	Pass
-10	+VOUT	Pass	Pass
	GND	Pass	Pass
+12	+VOUT	Pass	Pass
	GND	Pass	Pass
-12	+VOUT	Pass ¹	Pass
	GND	Pass ¹	Pass
+14	+VOUT	Pass	Pass
	GND	Pass	Pass
-14	+VOUT	Pass ¹	Pass
	GND	Pass ¹	Pass
+15	+VOUT	Pass	Pass
	GND	Pass	Pass
-15	+VOUT	Pass ¹	Pass ¹
	GND	Pass ¹	Pass ¹
+16.5	+VOUT	Pass	Pass
	GND	Pass	Pass
-16.5	+VOUT	Pass ¹	Pass ¹
	GND	Pass ¹	Pass ¹

¹Power supply might initiate Hard Reset due to either:

- InnoSwitch3-PD protection, or
- USB-C power adapter tester Tiny-PAT protection at the load

19.1.2 Air Discharge, On-board, 230 VAC Input

Discharge Voltage (kV)	ESD Strike Location (10 Strikes Each)	Test Result 20 V / 5 A	Test Result 5 V / 0 A with PD Sink	Test Result 5 V / 0 A without PD Sink
+8	+VOUT	Pass	Pass	Pass
	GND	Pass	Pass	Pass
-8	+VOUT	Pass	Pass	Pass
	GND	Pass	Pass	Pass
+10	+VOUT	Pass	Pass	Pass
	GND	Pass	Pass	Pass
-10	+VOUT	Pass	Pass	Pass
	GND	Pass	Pass	Pass
+12	+VOUT	Pass	Pass	Pass
	GND	Pass	Pass	Pass
-12	+VOUT	Pass	Pass	Pass
	GND	Pass	Pass	Pass
+14	+VOUT	Pass	Pass	Pass
	GND	Pass	Pass	Pass
-14	+VOUT	Pass ¹	Pass	Pass
	GND	Pass ¹	Pass	Pass
+15	+VOUT	Pass	Pass	Pass
	GND	Pass	Pass	Pass
-15	+VOUT	Pass ¹	Pass	Pass
	GND	Pass ¹	Pass	Pass
+16.5	+VOUT	Pass	Pass	Pass
	GND	Pass	Pass	Pass
-16.5	+VOUT	Pass ¹	Pass ¹	Pass
	GND	Pass ¹	Pass ¹	Pass

¹Power supply might initiate Hard Reset due to either:

- InnoSwitch3-PD protection, or
- USB-C power adapter tester Tiny-PAT protection at the load

19.1.3 Contact Discharge, End of Cable, 230 VAC Input

Discharge Voltage (kV)	ESD Strike Location (10 Strikes Each)	Test Result 20 V / 5 A	Test Result 5 V / 0 A with PD Sink	
+8.0	End of Cable	+VOUT	Pass ¹	Pass
		GND	Pass ¹	Pass
-8.0		+VOUT	Pass ¹	Pass
		GND	Pass ¹	Pass
+8.8		+VOUT	Pass ¹	Pass ¹
		GND	Pass ¹	Pass ¹
-8.8		+VOUT	Pass ¹	Pass ¹
		GND	Pass ¹	Pass ¹

¹Power supply might initiate Hard Reset due to either:

- InnoSwitch3-PD protection, or
- USB-C power adapter tester Tiny-PAT protection at the load

19.1.4 Contact Discharge, On the Board, 230 VAC Input

Discharge Voltage (kV)	ESD Strike Location (10 Strikes Each)	Test Result 20 V / 5 A	Test Result 5 V / 0 A with PD Sink	Test Result 5 V / 0 A without PD Sink	
+8.0	On the Board	+VOUT	Pass	Pass	
		GND	Pass	Pass	
-8.0		+VOUT	Pass	Pass	Pass
		GND	Pass	Pass	Pass
+8.8		+VOUT	Pass	Pass	Pass
		GND	Pass	Pass	Pass
-8.8		+VOUT	Pass	Pass	Pass
		GND	Pass	Pass	Pass

19.2 *CC1 and CC2 ESD Performance*

Discharge points were added to the communication lines of the USB PD Sink (TinyPAT) to test CC lines ESD performance. The two CC lines at the end of cable were differentiated by their voltage levels during the normal operation.

- Sink CC Line: Active (~ 1.7 V)
- Sink CC Line: Low (~ 0 V)

Performing ESD on CC lines using a 5 A cable with e-marker can damage the e-marker chip of the cable. A 1-meter 3 A passive USB Type C cable (Google) was used instead to evaluate the unit under test.

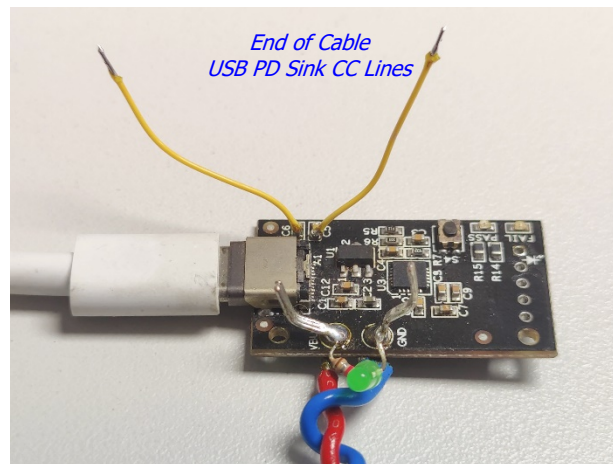

Figure 144 – ESD Discharge Points, USB PD Sink CC Lines.

19.2.1 Air Discharge, End of cable, 230 VAC Input

Discharge Voltage (kV)	ESD Strike Location (10 Strikes Each)	Test Result 20 V / 3 A	Test Result 5 V / 0 A with PD Sink	
+15	End of Cable	CC Line: Active	Pass ¹	Pass ¹
		CC Line: Low	Pass ¹	Pass ¹
-15		CC Line: Active	Pass ¹	Pass ¹
		CC Line: Low	Pass ¹	Pass ¹
+16.5		CC Line: Active	Pass ¹	Pass ¹
		CC Line: Low	Pass ¹	Pass ¹
-16.5		CC Line: Active	Pass ¹	Pass ¹
		CC Line: Low	Pass ¹	Pass ¹

¹Power supply might initiate Hard Reset due to either:

- InnoSwitch3-PD protection, or
- USB-C power adapter tester Tiny-PAT protection at the load

19.2.2 Contact Discharge, End of Cable, 230 VAC Input

Discharge Voltage (kV)	ESD Strike Location (10 Strikes Each)	Test Result 20 V / 3 A	Test Result 5 V / 0 A with PD Sink	
+8.0	End of Cable	CC Line: Active	Pass ¹	Pass ¹
		CC Line: Low	Pass ¹	Pass ¹
-8.0		CC Line: Active	Pass ¹	Pass ¹
		CC Line: Low	Pass ¹	Pass ¹
+8.8		CC Line: Active	Pass ¹	Pass ¹
		CC Line: Low	Pass ¹	Pass ¹
-8.8		CC Line: Active	Pass ¹	Pass ¹
		CC Line: Low	Pass ¹	Pass ¹

¹Power supply might initiate Hard Reset due to either:

- InnoSwitch3-PD protection, or
- USB-C power adapter tester Tiny-PAT protection at the load

20 Revision History

Date	Author	Revision	Description & Changes	Reviewed
18-Oct-21	DB	1.0	Initial Release.	Apps & Mktg

For the latest updates, visit our website: www.power.com

Reference Designs are technical proposals concerning how to use Power Integrations' gate drivers in particular applications and/or with certain power modules. These proposals are "as is" and are not subject to any qualification process. The suitability, implementation and qualification are the sole responsibility of the end user. The statements, technical information and recommendations contained herein are believed to be accurate as of the date hereof. All parameters, numbers, values and other technical data included in the technical information were calculated and determined to our best knowledge in accordance with the relevant technical norms (if any). They may be based on assumptions or operational conditions that do not necessarily apply in general. We exclude any representation or warranty, express or implied, in relation to the accuracy or completeness of the statements, technical information and recommendations contained herein. No responsibility is accepted for the accuracy or sufficiency of any of the statements, technical information, recommendations or opinions communicated and any liability for any direct, indirect or consequential loss or damage suffered by any person arising therefrom is expressly disclaimed.

Power Integrations reserves the right to make changes to its products at any time to improve reliability or manufacturability. Power Integrations does not assume any liability arising from the use of any device or circuit described herein. POWER INTEGRATIONS MAKES NO WARRANTY HEREIN AND SPECIFICALLY DISCLAIMS ALL WARRANTIES INCLUDING, WITHOUT LIMITATION, THE IMPLIED WARRANTIES OF MERCHANTABILITY, FITNESS FOR A PARTICULAR PURPOSE, AND NON-INFRINGEMENT OF THIRD PARTY RIGHTS.

Patent Information

The products and applications illustrated herein (including transformer construction and circuits' external to the products) may be covered by one or more U.S. and foreign patents, or potentially by pending U.S. and foreign patent applications assigned to Power Integrations. A complete list of Power Integrations' patents may be found at www.power.com. Power Integrations grants its customers a license under certain patent rights as set forth at <http://www.power.com/ip.htm>.

Power Integrations, the Power Integrations logo, CAPZero, ChiPhy, CHY, DPA-Switch, EcoSmart, E-Shield, eSIP, eSOP, HiperPLC, HiperPFS, HiperTFS, InnoSwitch, Innovation in Power Conversion, InSOP, LinkSwitch, LinkZero, LYTSwitch, SENZero, TinySwitch, TOPSwitch, PI, PI Expert, SCALE, SCALE-1, SCALE-2, SCALE-3 and SCALE-iDriver, are trademarks of Power Integrations, Inc. Other trademarks are property of their respective companies. ©2019, Power Integrations, Inc.

Power Integrations Worldwide Sales Support Locations

WORLD HEADQUARTERS

5245 Hellyer Avenue
San Jose, CA 95138, USA.
Main: +1-408-414-9200
Customer Service:
Worldwide: +1-65-635-64480
Americas: +1-408-414-9621
e-mail: usasales@power.com

CHINA (SHANGHAI)

Rm 2410, Charity Plaza, No. 88,
North Caoxi Road,
Shanghai, PRC 200030
Phone: +86-21-6354-6323
e-mail:
chinasales@power.com

CHINA (SHENZHEN)

17/F, Hivac Building, No. 2,
Keji Nan 8th Road, Nanshan
District, Shenzhen, China,
518057
Phone: +86-755-8672-8689
e-mail:
chinasales@power.com

GERMANY (AC-DC/LED

Sales)
Einsteinring 24
85609 Dornach/Aschheim
Germany
Tel: +49-89-5527-39100
e-mail:
eurosales@power.com

GERMANY (Gate Driver

Sales)
HellwegForum 1
59469 Ense
Germany
Tel: +49-2938-64-39990
e-mail: igbt-driver.sales@power.com

INDIA

#1, 14th Main Road
Vasanthanagar
Bangalore-560052
India
Phone: +91-80-4113-8020
e-mail:
indiasales@power.com

ITALY

Via Milanese 20, 3rd. Fl.
20099 Sesto San Giovanni (MI)
Italy
Phone: +39-024-550-8701
e-mail: eurosales@power.com

JAPAN

Yusen Shin-Yokohama 1-chome
Bldg.
1-7-9, Shin-Yokohama, Kohoku-ku
Yokohama-shi,
Kanagawa 222-0033 Japan
Phone: +81-45-471-1021
e-mail: japansales@power.com

KOREA

RM 602, 6FL
Korea City Air Terminal B/D,
159-6
Samsung-Dong, Kangnam-Gu,
Seoul, 135-728 Korea
Phone: +82-2-2016-6610
e-mail: koreasales@power.com

SINGAPORE

51 Newton Road,
#19-01/05 Goldhill Plaza
Singapore, 308900
Phone: +65-6358-2160
e-mail:
singaporesales@power.com

TAIWAN

5F, No. 318, Nei Hu Rd.,
Sec. 1
Nei Hu District
Taipei 11493, Taiwan R.O.C.
Phone: +886-2-2659-4570
e-mail:
taiwansales@power.com

UK

Building 5, Suite 21
The Westbrook Centre
Milton Road
Cambridge
CB4 1YG
Phone: +44 (0) 7823-557484
e-mail: eurosales@power.com

